

chill index

Edition : September 2018

Retail Prices (Ex GST)



www.orford.com.au

Orford Chill Index

Refrigerators—General

- [Page 4](#)
- Orford FMB20 [Page 5](#)
- Orford FMB Black [Page 6](#)
- Orford FMB30 [Page 7](#)
- Orford EB20 EcoChill™ Range [Page 8](#)
- Orford EB30 EcoChill™ Range [Page 9](#)
- Orford EB36 EcoChill™ Range [Page 10](#)
- Orford EB45 EcoChill™ Range [Page 12](#)
- Orford EB EcoChill™ Energy Figures [Page 14](#)
- Halo HR350 Slim [Page 15](#)
- Halo SD Refrigerator Range [Page 17](#)

Freezer— General

- [Page 20](#)
- Orford VB36L Freezer [Page 21](#)
- Halo Freezer Range [Page 22](#)

Refrigerator—Specialties

- [Page 26](#)
- Orford Flower Fridges 4U [Page 27](#)
- Orford Wine Fridges [Page 29](#)
- Orford Chocolate Fridges [Page 34](#)
- Orford Cake Fridges/Freezers [Page 37](#)

Freezer—Specialties

- [Page 41](#)
- Orford VB36 IM Ice Merchandiser [Page 42](#)

Underbench / Underbars

- [Page 43](#)
- Orford BB Backbar Range [Page 44](#)
- Halo KUR Undercounter Refrigerator [Page 47](#)
- Halo KUF Undercounter Freezer [Page 48](#)
- Halo KURF Undercounter Combos [Page 49](#)
- Halo AUR Economy Undercounter Refrigerator [Page 51](#)
- Halo AUF Economy Undercounter Freezer [Page 52](#)

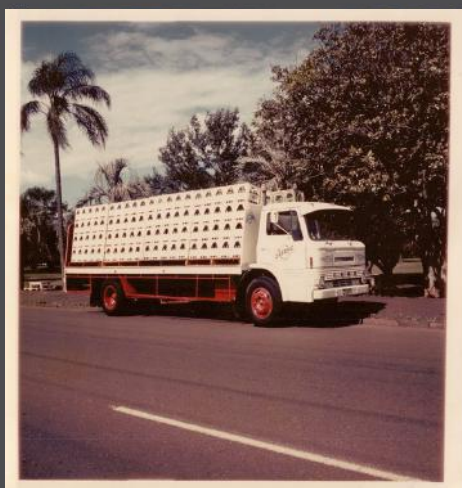

chill index

www.orford.com.au

www.halorefrigeration.com.au

1300 ORFORD

1300 673 673

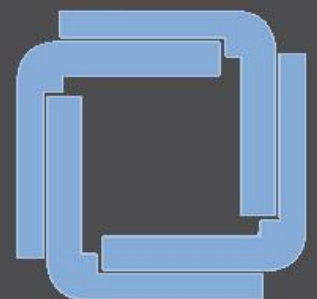

Orford Chill Index

Halo Food Services

[Page 53](#)

Halo KRF Fridge/Freezer

[Page 54](#)

Halo KR Refrigerator

[Page 58](#)

Halo KR Glass Refrigerator

[Page 59](#)

Halo KR Glass Half Door Refrigerator

[Page 60](#)

Halo KR Freezer

[Page 61](#)

Halo KR Glass Freezer

[Page 62](#)

Halo 20 Milk Dispenser

[Page 63](#)

Halo TOG Salad Table

[Page 64](#)

Halo KHR Salad Table

[Page 65](#)

Manitowoc Ice Machines

[Page 66](#)

Manitowoc UG Series

[Page 68](#)

Manitowoc Neo U Series

[Page 70](#)

Manitowoc Indigo Series

[Page 72](#)

Manitowoc Flakers

[Page 78](#)

Manitowoc Filter Assemblies

[Page 84](#)

Manitowoc M Series

[Page 85](#)

Manitowoc Accessories

[Page 87](#)

Manitowoc Commercial Warranty

[Page 88](#)

Orford Insert Doors

[Page 89](#)

Insert Door Sizes

[Page 91](#)

Insert Door Checklist

[Page 92](#)

Orford Finance

[Page 93](#)

Orford Sign Shop

[Page 94](#)

Terms & Conditions

[Page 95](#)

MEPS / Cabinets & Climate Class

[Page 97](#)

Contact Us

[Page 100](#)

Prices are excluding GST, Freight and Insurance



chill index

www.orford.com.au

www.halorefrigeration.com.au

1300 ORFORD

1300 673 673

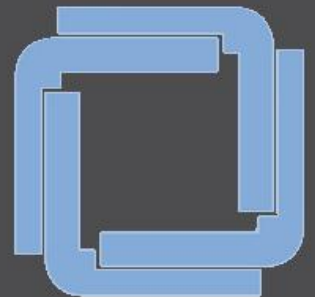



fridge
-general

Do you have an ABN?
Contact us for a trade discount!

FMB20	Vertical Display Refrigerator
Capacity	557 Litres (Gross)
Dimensions	740W x 791D x 2010H
Weight	165Kg
Operating Temp	0° - 5° C.
Ambient Temp	0° - 40° C.
Range	
Power Point	230 - 240v 50Hz. (Standard GPO)
Thermometer	Mechanical
Shelves	4 Height Adjustable Heavy Duty PVC Coated
Shelf Adjustment	12mm Increments
Door	1 x Self Closing, Double Glazed Safety Glass, Single Heat reflective Low E, Argon filled, Right Hand hinged.
Footings	Heavy Duty Castors, Lockable Front
Compressor	Danfoss
Interior Light	LED (on/off switch included)
Refrigerant	R134A
Insulation	50mm Polyurethane, CFC, HCFC, HFC Free
Climate Class	Class 5
MEPS	Compliant (High Efficiency)
Condenser Filter	Rear mounted

FMB20-Sn	Vertical Display Refrigerator with Illuminated Advertising Sign
Construction	Powder Coated galvanized steel Int / Ext White
Capacity	557Litres (Gross)
Dimensions	740W x 791D x 2200H
Weight	165Kg
Operating Temp	0° - 5° C.
Ambient Temp	0° - 40° C.
Range	
Power Point	230 - 240v 50Hz. (Standard GPO)
Thermometer	Mechanical
Shelves	4 Height Adjustable Heavy Duty PVC Coated
Shelf Adjustment	12mm Increments
Door	1 x Self Closing, Double Glazed Safety Glass, Single Heat reflective Low E, Argon filled, Right Hand hinged.
Footings	Heavy Duty Castors, Lockable Front
Compressor	Danfoss
Interior Light	LED (on/off switch included)
Refrigerant	R134A
Insulation	50mm Polyurethane, CFC, HCFC, HFC Free
Climate Class	Class 5
MEPS	Compliant (High Efficiency)
Condenser Filter	Rear mounted
Illuminated Advertising Sign	200mm High, Top Mounted.
Sign Illumination	LED

Orford FMB20
RRP : \$2600 + GST



Energy consumed : 5.425 kWh/24hr

Orford FMB20Sn
RRP : \$2745 + GST



Energy consumed : 5.589 kWh/24hr

Do you have an ABN?
Contact us for a trade discount!

FMB20-Sn	Vertical Display Refrigerator with Illuminated Advertising Sign
Construction	Powder Coated galvanized steel Int / Ext White
Capacity	557Litres (Gross)
Dimensions	740W x 791D x 2200H
Weight	165Kg
Operating Temp	0° - 5° C.
Ambient Temp Range	0° - 40° C.
Power Point	230 - 240v 50Hz. (Standard GPO)
Thermometer	Mechanical
Shelves	4 Height Adjustable Heavy Duty PVC Coated
Shelf Adjustment	12mm Increments
Door	1 x Self Closing, Double Glazed Safety Glass, Argon filled Single Heat reflective Low E, Right Hand hinged.
Footings	Heavy Duty Castors, Lockable Front
Compressor	Danfoss
Interior Light	LED (on/off switch included)
Refrigerant	R134A
Insulation	50mm Polyurethane, CFC, HCFC, HFC Free
Climate Class	Class 5
MEPS	Compliant (High Efficiency)
Condenser Filter	Rear mounted
Illuminated Advertising Sign	200mm High, Top Mounted.
Sign Illumination	LED

Orford FMB20Sn—Black
RRP : \$2745 + GST



Energy consumed : 5.425

FMB30-Sn	Vertical Display Refrigerator with Illuminated Advertising Sign
Construction	Powder Coated galvanized steel Int/ Ext White
Capacity	889 Litres (Gross)
Dimensions	1130W x 791D x 2200H
Weight	210Kg
Operating Temp	0° - 5° C.
Ambient Temp Range	0° - 40° C.
Power Point	230 - 240v 50Hz. (Standard GPO)
Thermometer	Mechanical
Shelves	8 Height Adjustable Heavy Duty PVC Coated
Shelf Adjustment	12mm Increments
Door	1 x Self Closing, Double Glazed Safety Glass, Argon filled Single Heat reflective Low E, Right Hand hinged.
Footings	Heavy Duty Castors, Lockable Front
Compressor	Danfoss
Interior Light	LED (on/off switch included)
Refrigerant	R134A
Insulation	50mm Polyurethane, CFC, HCFC, HFC Free
Climate Class	Class 5
MEPS	Compliant (High Efficiency)
Condenser Filter	Rear mounted
Illuminated Advertising Sign	200mm High, Top Mounted.
Sign Illumination	LED

Orford FMB30Sn-Black
RRP : \$3408 + GST



Energy consumed : 5.589 kWh/24hr

Do you have an ABN?
Contact us for a trade discount!

FMB30	Vertical Display Refrigerator
Construction	Powder Coated galvanized steel Interior /
Capacity	889 Litres (Gross)
Dimensions	1130W x 791D x 2010H
Weight	210Kg
Operating Temp	0° - 5° C.
Ambient Temp Range	0° - 40° C.
Power Point	230 - 240v 50Hz. (Standard GPO)
Thermometer	Mechanical
Shelves	8 Height Adjustable Heavy Duty PVC Coated
Shelf Adjustment	12mm Increments
Door	1 x Self Closing, Double Glazed Safety Glass, Single Heat reflective Low E, Argon filled,
Footings	Heavy Duty Castors, Lockable Front
Compressor	Danfoss
Interior Light	LED (on/off switch included)
Refrigerant	R134A
Insulation	50mm Polyurethane, CFC, HCFC, HFC Free
Climate Class	Class 5
MEPS	Compliant (High Efficiency)
Condenser Filter	Rear mounted

Orford FMB30
RRP : \$3265 + GST



Energy consumed : 7.59 kWh/24hr

FMB30-Sn	Vertical Display Refrigerator with Illuminated Advertising Sign
Construction	Powder Coated galvanized steel Int/ Ext White
Capacity	889 Litres (Gross)
Dimensions	1130W x 791D x 2200H
Weight	210Kg
Operating Temp	0° - 5° C.
Ambient Temp Range	0° - 40° C.
Power Point	230 - 240v 50Hz. (Standard GPO)
Thermometer	Mechanical
Shelves	8 Height Adjustable Heavy Duty PVC Coated
Shelf Adjustment	12mm Increments
Door	1 x Self Closing, Double Glazed Safety Glass, Single Heat reflective Low E, Argon filled, Right Hand hinged.
Footings	Heavy Duty Castors, Lockable Front
Compressor	Danfoss
Interior Light	LED (on/off switch included)
Refrigerant	R134A
Insulation	50mm Polyurethane, CFC, HCFC, HFC Free
Climate Class	Class 5
MEPS	Compliant (High Efficiency)
Condenser Filter	Rear mounted
Illuminated Advertising Sign	200mm High, Top Mounted.
Sign Illumination	LED

Orford FMB30Sn
RRP : \$3408 + GST



Energy consumed : 8 kWh/24hr

Do you have an ABN?
Contact us for a trade discount!

EB20R-Sn Specifications	Vertical Display Refrigerator with Illuminated Advertising Sign
Construction	Powder Coated galvanized steel Interior / Exterior White
Capacity	595 Litres (Gross)
Dimensions	756W x 762D x 2220H
Weight	155Kg
Operating Temp	0° - 5° C.
Ambient Temp Range	0° - 40° C.
Power Point	220 - 240v 50Hz. (Standard GPO)
Input Current	2.8 Amps
Thermometer	Digital
Shelves	4 Height Adjustable Heavy Duty PVC Coated
Shelves	1 Fixed Stainless Steel Base Shelves
Shelf Adjustment	12mm Increments
Refrigerated Shelf Area	1.42 m ²
Condensate Disposal	Automatic by energy efficient, No Cost, Hot Gas
Door	1 x Self Closing, Double Glazed Safety Glass, Double Heat reflective Low E, Warm edge, R/H
Footings	Heavy Duty Castors, Lockable Front
Interior Light	LED, Automatic and manual control
Refrigerant	R134a
Drier	Solid Core
Insulation	50mm Polyurethane, CFC, HCFC, HFC Free
Cabinet Classes	3M1, 4M1, 5M1
MEPS	Compliant (High Efficiency)
* Energy Consumption	3.43 kWh/24h
Condenser Filter	Easy front access
Illuminated Advertising Sign	200mm High, Top Mounted
Sign Illumination	LED, Automatic and manual control

RRP : \$4035 + GST
Orford EB20R-Sn-A

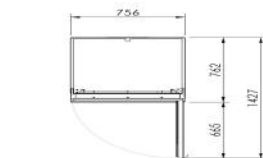

IP Protected by AUS DSN no 345317
& Patent NO 2013100761

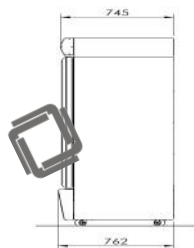
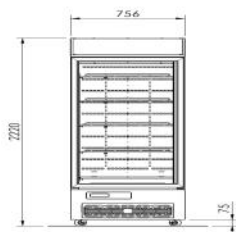

The Orford Group EB Model	Energy Consumption @3M1 kWh/24hr
EB20R-A	3.17
EB20R-SN-A with illuminated sign	3.43



Do you have an ABN?
Contact us for a trade discount!

EB30R-Sn Specifications	Vertical Display Refrigerator with Illuminated Advertising Sign
Construction	Powder Coated galvanized steel Interior /Exterior White
Capacity	895 Litres (Gross)
Dimensions	1094W x 762D x 2220H
Weight	210Kg
Operating Temp	0° - 5° C.
Ambient Temp Range	0° - 40° C.
Power Point	220 - 240v 50Hz. (Standard GPO)
Input Current	2.8 Amps
Thermometer	Digital
Shelves	8 Height Adjustable Heavy Duty PVC Coated
Shelves	2 Fixed Stainless Steel Base Shelves
Shelf Adjustment	12mm Increments
Refrigerated Shelf Area	2.17 m ²
Condensate Disposal	Automatic by energy efficient, No Cost, Hot Gas
Door	2 x Self Closing, Double Glazed Safety Glass, Double Heat reflective Low E, Warm edge
Footings	Heavy Duty Castors, Lockable Front
Interior Light	LED, Automatic and manual control
Refrigerant	R134a
Cabinet Classes	3M1, 4M1, 5M1
MEPS	Compliant (High Efficiency)
* Energy Consumption	4.24 kWh/24h
Condenser Filter	Easy front access
Illuminated Advertising Sign	200mm High, Top Mounted
Sign Illumination	LED, Automatic and manual control

RRP : \$4622 + GST
Orford EB30R-Sn-A

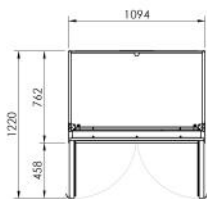

IP Protected by AUS DSN no 345317
& Patent NO 2013100761

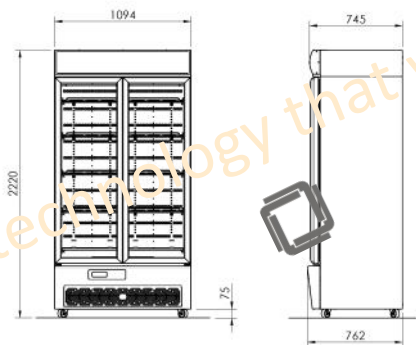

The Orford Group EB Model	Energy Consumption @3M1 kWh/24hr
EB30R-A	3.78
EB30R-SN-A with illuminated sign	4.24



Do you have an ABN?
Contact us for a trade discount!

EB36R-Sn Specifications	Vertical Display Refrigerator with Illuminated Advertising Sign
Construction	Powder Coated galvanized steel Interior /Exterior White
Capacity	1071 Litres (Gross)
Dimensions	1286W x 762D x 2220H
Weight	221Kg
Operating Temp	0° - 5° C.
Ambient Temp Range	0° - 40° C.
Power Point	220 - 240v 50Hz. (Standard GPO)
Input Current	2.9 Amps
Thermometer	Digital
Shelves	8 Height Adjustable Heavy Duty PVC Coated
Shelves	2 Fixed Stainless Steel Base Shelves
Shelf Adjustment	12mm Increments
Door	2 x Self Closing, Double Glazed Safety Glass, Double Heat reflective Low E, Warm edge
Footings	Heavy Duty Castors, Lockable Front
Interior Light	LED, Automatic and manual control
Refrigerant	R134a
Drier	Solid Core
Insulation	50mm Polyurethane, CFC, HCFC, HFC Free
Cabinet Classes	3M1, 4M1, 5M1
MEPS	Compliant (High Efficiency)
* Energy Consumption	4.74 kWh/24h
Condenser Filter	Easy front access
Illuminated Advertising Sign	200mm High, Top Mounted
Sign Illumination	LED, Automatic and manual control

RRP : \$5193 + GST
Orford EB36R-Sn-A

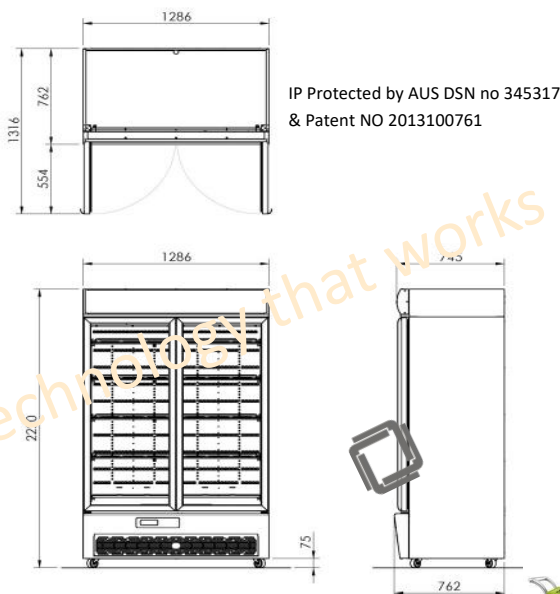

The Orford Group EB Model	Energy Consumption @3M1 kWh/24hr
EB36R-A	4.28
EB36R-SN-A with illuminated sign	4.74



Do you have an ABN?
Contact us for a trade discount!

EB36R-Sn-PT	Rear Loading Display Refrigerator with Illuminated Advertising Sign
Specifications	
Construction	Powder Coated galvanized steel Interior /Exterior White
Capacity	1071 Litres (Gross)
Dimensions	1286W x 762D x 2220H
Weight	221Kg
Operating Temp	0° - 5° C.
Ambient Temp Range	0° - 40° C.
Power Point	220 - 240v 50Hz. (Standard GPO)
Input Current	2.9 Amps
Thermometer	Digital
Shelves	8 Height Adjustable Heavy Duty PVC Coated
Shelves	2 Fixed Stainless Steel Base Shelves
Shelf Adjustment	12mm Increments
Door + Rear doors	2 x Self Closing, Double Glazed Safety Glass, Double Heat reflective Low E, Warm edge
Footings	2 x Self closing powdercoated doors Heavy Duty Castors, Lockable Front
Interior Light	LED, Automatic and manual control
Refrigerant	R134a
Drier	Solid Core
Insulation	50mm Polyurethane, CFC, HCFC, HFC Free
Cabinet Classes	3M1, 4M1, 5M1
MEPS	Compliant (High Efficiency)
* Energy Consumption	4.74 kWh/24h
Condenser Filter	Easy front access
Illuminated Advertising Sign	200mm High, Top Mounted
Sign Illumination	LED, Automatic and manual control

RRP : \$5543 + GST
Orford EB36R-Sn-A-PT

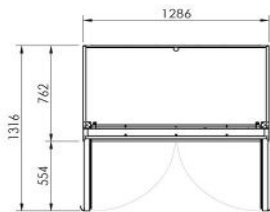
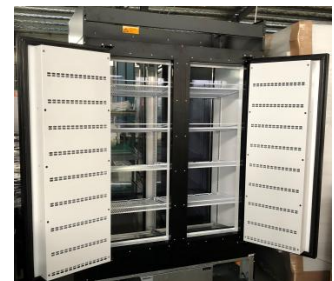

IP Protected by AUS DSN no 345317
& Patent NO 2013100761

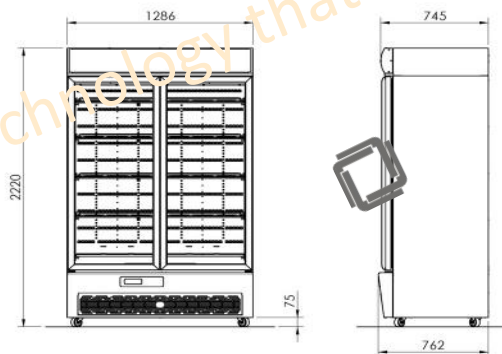

technology that works



Do you have an ABN?
Contact us for a trade discount!

EB45R-Sn Specifications	Vertical Display Refrigerator with Illuminated Advertising Sign
Construction	Powder Coated galvanized steel Interior / Exterior White
Capacity	1384 Litres (Gross)
Dimensions	1640W x 762D x 2220H
Weight	265 Kg
Operating Temp	0° - 5° C.
Ambient Temp Range	0° - 40° C.
Power Point	220 - 240v 50Hz. (Standard GPO)
Input Current	3.2 Amps
Thermometer	Digital
Shelves	12 Height Adjustable Heavy Duty PVC Coated
Shelves	3 Fixed Stainless Steel Base Shelves
Shelf Adjustment	12mm Increments
Refrigerated Shelf Area	3.38 m ²
Condensate Disposal	Automatic by energy efficient, No Cost, Hot Gas
Door	3 x Self Closing, Double Glazed Safety Glass, Double Heat reflective Low E, Warm edge
Footings	Heavy Duty Castors, Lockable Front
Interior Light	LED, Automatic and manual control
Refrigerant	R134a
Cabinet Classes	3M1, 4M1, 5M1
MEPS	Compliant (High Efficiency)
* Energy Consumption	6.03 kWh/24h
Condenser Filter	Easy front access
Illuminated Advertising Sign	200mm High, Top Mounted
Sign Illumination	LED, Automatic and manual control

RRP : \$6480 + GST
Orford EB45R-Sn-A

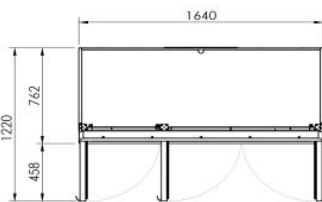

IP Protected by AUS DSN no
345317 & Patent NO 2013100761

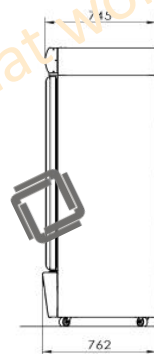
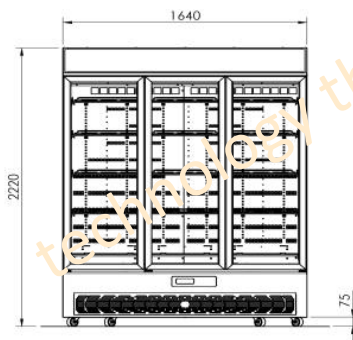

The Orford Group EB Model	Energy Consumption @3M1 kWh/24hr
EB45R-A	5.45
EB45R-SN-A with illuminated sign	6.03



Do you have an ABN?
Contact us for a trade discount!

EB45R-Sn-PT Specifications	Rear Loading Display Refrigerator with Illuminated Advertising Sign
Construction	Powder Coated galvanized steel Interior / Exterior White
Capacity	1384 Litres (Gross)
Dimensions	1640W x 762D x 2220H
Weight	265 Kg
Operating Temp	0° - 5° C.
Ambient Temp Range	0° - 40° C.
Power Point	220 - 240v 50Hz. (Standard GPO)
Input Current	3.2 Amps
Thermometer	Digital
Shelves	12 Height Adjustable Heavy Duty PVC Coated
Shelves	3 Fixed Stainless Steel Base Shelves
Shelf Adjustment	12mm Increments
Refrigerated Shelf Area	3.38 m ²
Condensate Disposal	Automatic by energy efficient, No Cost, Hot Gas 3 x Self Closing, Double Glazed Safety Glass,
Door	Double Heat reflective Low E, Warm edge 3 x Self closing powder coated rear doors
Footings	Heavy Duty Castors, Lockable Front
Interior Light	LED, Automatic and manual control
Refrigerant	R134a
Cabinet Classes	3M1, 4M1, 5M1
MEPS	Compliant (High Efficiency)
* Energy Consumption	6.03 kWh/24h
Condenser Filter	Easy front access
Illuminated Advertising Sign	200mm High, Top Mounted
Sign Illumination	LED, Automatic and manual control

RRP : \$6870 + GST
Orford EB45R-Sn-PT

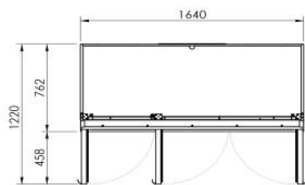

IP Protected by AUS DSN no 345317
& Patent NO 2013100761

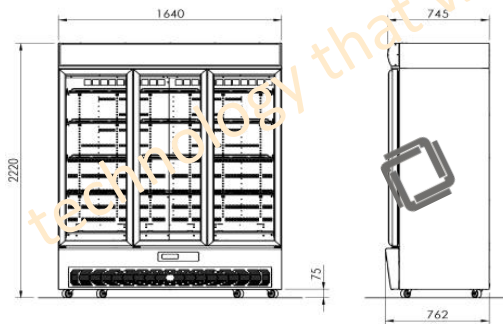

try to find a supplier that works



Do you have an ABN?
Contact us for a trade discount!



The Orford Group Patented EB Model	Energy Consumption @ 3M1 kWh/24hr	Running Cost based on power at .28c per kW
EB20R-A	3.17	3.17 @ .28c = .89c per day = \$324.84 per annum
EB20R-Sn-A (with sign box)	3.43	3.43 @ .28c = .96c per day = \$350.40 per annum
EB30R-A	3.78	3.78 @ 28c = \$1.06c per day = \$386.90 per annum
EB30R-Sn-A (with sign box)	4.24	4.24 @ 28c = \$1.19 per day = \$434.35 per annum
EB36R-A	4.28	4.28 @ 28c = \$1.20 per day = \$428.00 per annum
EB36R-Sn-A (with sign box)	4.74	4.74 @ 28c = \$1.33 per day = \$485.45 per annum
EB45R-A	5.45	5.45 @ 28c = \$1.53 per day = \$558.45 per annum
EB45R-Sn-A (with sign box)	6.03	6.03 @ 28c = \$1.69 per day = \$616.85 per annum



technology that works

IP Protected by AUS DSN no 345317 & Patent NO 2013100761



Do you have an ABN?
Contact us for a trade discount!



**Halo SGR 25—1G
510 Litre Fridge
RRP : \$4,200 + GST**

Halo SGR 25-1G	Vertical Display Refrigerator
Dimensions	640Wx800Dx2050H
Capacity	510 Litres
Operating Temperature	1° - 8° C.
Tested Temperature	Up to 35° C ambient
Shelves	4
Temperature Controller	Digital Temperature Controller



**Halo HR 350 Slim 386 Litre Fridge
RRP : \$1,592 + GST**

Halo SGR 25-1G	Vertical Display Refrigerator
Dimensions	620Wx610Dx1945H
Weight	86kg
Capacity	510 Litres
Operating Temperature	0° - 10° C.
Tested Temperature	Up to 35° C ambient
Shelves	4
Door	Self closing door with double glazed safety glass with single heat reflective Low E glass, Door lock standard
Refrigerant	R600a
Footings	4 castors, 2 with brakes
MEPS	Compliant, Electrically Compliant
Temperature Controller	Digital Dixell Blue Line Temperature controller
Compressor	Zanussi Compressor
Sign	Built in advertising sign with light

Do you have an ABN?
Contact us for a trade discount!



Halo HR350 Slim

RRP \$1592 + GST

The Halo HR 350 Slim offers eye catching appeal to increase impulse sales. A versatile and energy efficient solution for your cooling requirements.

www.halorefrigeration.com.au

Features

- ◆ Elegant Slim-line styled, Reach-in Display Cooler for Storage and Merchandising
- ◆ Strong well-constructed body
- ◆ LED Light, offering, Long life, brilliant merchandising, stunning product visibility and energy savings.
- ◆ Energy efficient, self-closing glass door
- ◆ Plug and Use—power requirements Standard 10 Amp. Power point
- ◆ Low Global Warming Refrigerant R600a adding a new dimension to environmental efficiency.
- ◆ Easy grip integrated handle
- ◆ Dixell controller, which also houses the light switch

Halo Slimline Specifications	Vertical Display Cooler with Illuminated Advertising Sign
Construction	Powder Coated galvanized steel Interior / Exterior White
Capacity	386 Litres (Gross)
Dimensions	620 W x 610 D x 1945 H
Weight	86Kg
Operating Temp	0° - 10° C.
Ambient Temperature	35° C.
Power Point	220 - 240v 50Hz. (Standard GPO)
Thermometer	Blue Line Dixell digital thermostat
Shelves	4 Height Adjustable Heavy Duty PVC Coated
Shelf Adjustment	12mm Increments
Condensate Disposal	Automatic by energy efficient, No Cost, Hot Gas
Door	1 x Self Closing, Double Glazed Safety Glass, Single Heat reflective Low E, Right Hand hinged. With door locks
Footings	2 adjustable feet at front and 2 rollers at the back
Interior Light	LED (on/off switch included)
Refrigerant	R600a
Insulation	Polyurethane, CFC, HCFC, HFC Free
Climate Class	Class 4
MEPS	Compliant (High Efficiency)
Condenser Filter	Rear mounted
Advertising Sign	Top of the Door (illuminated)



Halo TGM-5SD Refrigerator RRP \$2675 + GST



167 Litre refrigerator with LED light

Temp : 0—10 degrees

Levelling Feet

Double Pane glass doors with Heat Reflecting film

R134a Refrigerant

2 Shelves

External : 635 W x 590 D x 775 H

Weight 69kg

10 Amp plug

Halo TGM-10SD 263 Lt Refrigerator

RRP \$3225+ GST

LED light Temp : 0—10 degrees

Levelling Feet R134a Refrigerant 4 shelves

Double Pane glass doors with Heat Reflecting film

External : 655 W x 590 D x 1380 H Weight

69kg

10 Amp plug



Do you have an ABN?
Contact us for a trade discount!

Orford
REFRIGERATION



Halo SD Range

Do you have an ABN?
Contact us for a trade discount!

Halo TGM-15SD Refrigerator RRP \$ 4365 + GST

450 litre refrigerator LED lights

External : 670W x 630D x 1920H

Internal : 560W x 515D x 1560H

5 shelves standard weight: 109kg 10 Amp plug

Available in black or white



Halo TGM-23 SD 597 Lt Refrigerator RRP \$4585+ GST

LED light Temp : 0—10 degrees Levelling Feet
R134a 5 shelves Double Pane glass doors with Heat Reflecting film

External : 685 W x 770 D x 1955 H Weight 150kg

10 Amp plug

Orford
REFRIGERATION



Do you have an ABN?
Contact us for a trade discount!

Halo TGM-35SD Slimline Refrigerator RRP \$ 5385 + GST

1047 litre refrigerator LED lights

External : 1004 W x 809 D x 1956 H

Internal : 904 W x 699 D x 1535 H

10 shelves standard weight 197 kg

10 Amp plug Available in black or white



Halo TGM-47SD Refrigerator RRP \$6550 + GST

1308 litre refrigerator LED lights

External : 1299 W x 809 D x 1956 H

Internal : 1199 W x 699 D x 1535 H

10 shelves standard weight: 230kg 10 Amp plug

Available in black or white

Halo TGM-72SD 2019 litre REFRIGERATOR RRP \$9585 + GST

External : 1981 W x 809 D x 1956 H

Internal : 1891 W x 709 D x 1556 H

15 shelves standard weight: 310kg

15 Amp plug

LED lights Available in black or white



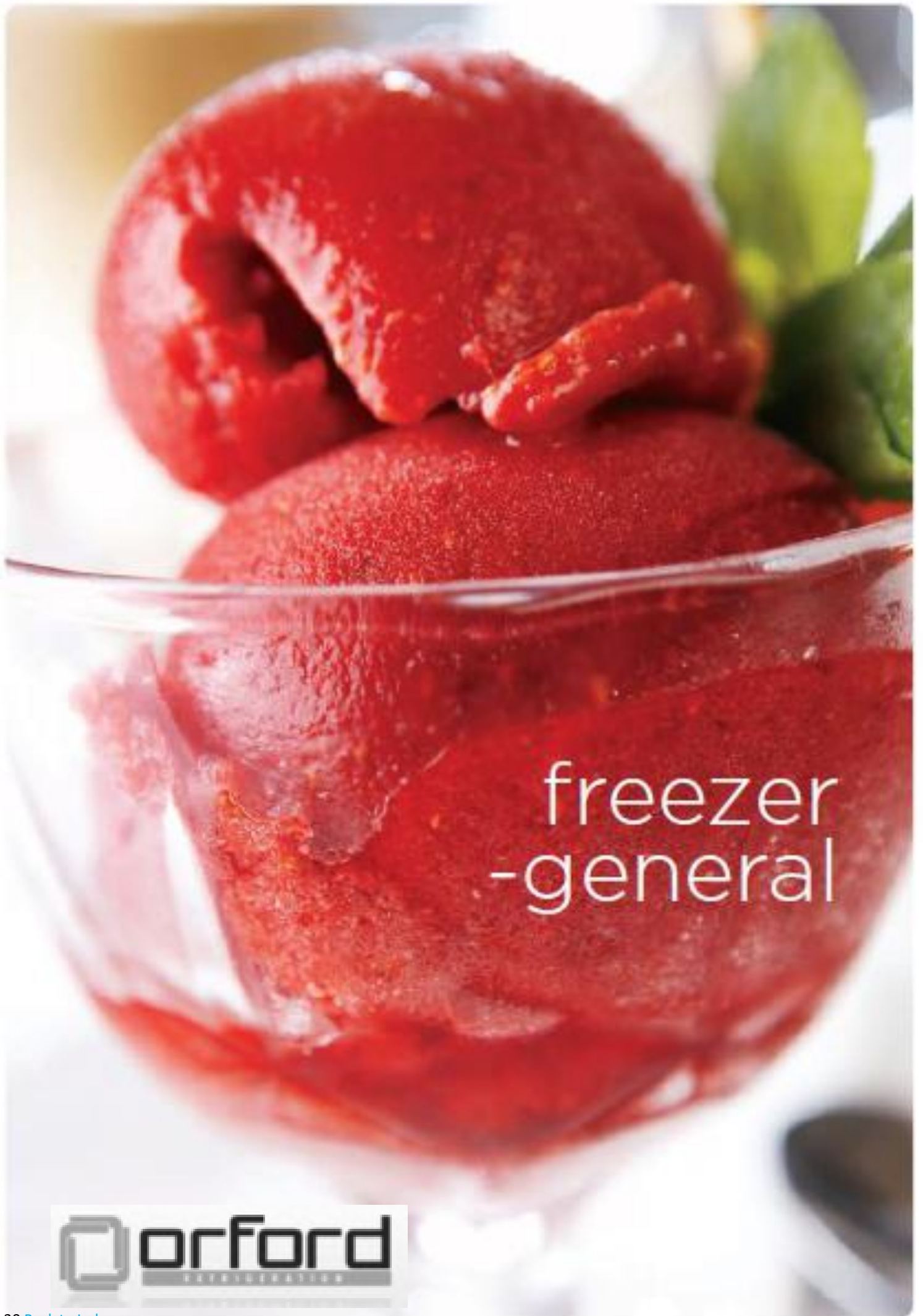

freezer
-general



Do you have an ABN?
Contact us for a trade discount!

VB36L-Sn-A Specifications	Vertical Display Ice Freezer with Illuminated Advertising Sign
Construction	Powder Coated galvanized steel Interior /Exterior White
Capacity	1071 Litres (Gross)
Dimensions	1286W x 866 D (+82 overhang = 952mm total) x 2215H (mm)
Weight	250 Kg (net)
Operating Temp	-19° to -23° C.
Ambient Temp Range	0° - 40° C.
Power Point	220 - 240v 50Hz. (15AMP power outlet)
Input Current	6.3 Amps
Thermometer	Digital
Shelves	8 Height Adjustable Heavy Duty PVC Coated
Shelves	2 Fixed Stainless Steel Base Shelves
Shelf Adjustment	12mm Increments
Refrigerated Shelf Area	2.62 m ²
Condensate Disposal	Automatic by energy efficient, No Cost, Hot Gas
Full Handled Door	2 x Self Closing, Triple Glazed Safety Glass, Argon filled with double heat reflective Low E, Warm edge with removable torsion bar, heated frame
Footings	Heavy Duty Castors, Lockable Front
Interior Light	LED, Automatic and manual control
Refrigerant	R404a
Drier	Solid Core
Insulation	60mm Polyurethane, CFC, HCFC, HFC Free
Cabinet Classes	3L1, 4L2, 5L3 up to 40 degree Celsius ambient
MEPS	Compliant (High Efficiency)
* Energy Consumption	20.73 kWh/24h/m ²
Condenser Filter	Easy front access
Illuminated Advertising Sign	205mm High, Top Mounted
Sign Illumination	LED, Automatic (motion sensor control) and manual control
Temperature Alarms	High and low temperature alarms
HACCP Function	Alarm system
Defrost	Energy Efficient Hot Gas
Sign Illumination	LED, Automatic and manual control

FREEZERS

Orford VB36L-Sn-A Freezer

RRP : \$8885 + GST

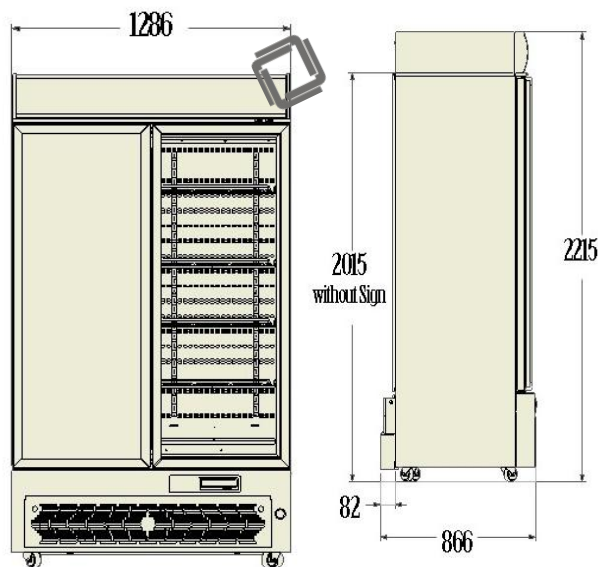

The Orford Group VB Freezer Model	Energy Consumption @3L1 kWh/24hr
VB36L-Sn-A	20.73

Introducing the 2016 Orford Bottom Mount VB36L-Sn-A Freezer with a removable package.

Matches the Orford EB Range

100% designed by the Orford Engineering Team

Patent Protected in Australia & New Zealand



Do you have an ABN?
Contact us for a trade discount!



Halo SGF 25- 1G 510 Lt Freezer

RRP \$5,800 + GST

Dimensions : 640mm w x 800mm d x 2050 h Capacity : 510 Litres

Operating Temperature : -18°C — 27°C

Tested to 35°C ambient Shelves : 4

Digital Temperature Controller Weight 150 kg

PLAN VIEW

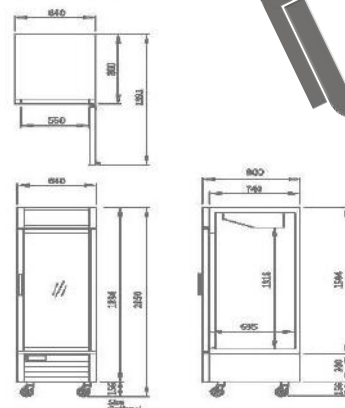

Halo TOG G1F-650

Freezer

RRP \$4860 + GST

650 litre freezer with Digital Temperature Control

LED lights

-16 to -24 degrees

External : 685 W x 760 D x 1984

4 shelves standard weight : 171 kg 10 Amp plug



Halo TOG G2F-1250

Freezer

RRP \$7950 + GST

1250 litre refrigerator

LED lights

-16 to -24 degrees

External : 1382 W x 760 D x 1984 H

10 shelves standard weight: 266kg 15 Amp plug



Do you have an ABN?
Contact us for a trade discount!



Halo TGF-5SD Freezer RRP \$3600 + GST

167 litre freezer with LED lights
Triple Pane Heated Glass doors with heat reflecting film
Self closing door R404A Refrigerant
-16 to -24 degrees 3 shelves standard

Halo TGF-10SD Single Door Freezer 263lt RRP \$4765 + GST

LED lights Triple Pane Heated Glass doors with heat Reflecting Film
Self closing door. Freezer has levelling feet. R404A refrigerant
Rated Temp -16 to -24 degrees 4 shelves as standard
655W x 590 D x 1380 H Weight 89 kg
Available in black or white
10amp Insulated Australian Plug



Halo TGF-15SD Freezer RRP \$5785 + GST

450 litre freezer with Digital Temperature Control
LED lights
-16 to -24 degrees
External : 670W x 630D x 1920H
Internal : 560W x 515 D x 1560H
5 shelves standard weight : 142kg 10 Amp plug
Available in Black or White

Do you have an ABN?
Contact us for a trade discount!



Halo SGF-25-1

Freezer

RRP \$5800 + GST

510 litre freezer with LED lights with Shadow free advertising panel

Dims : 640 w x 800 D x 2050 H (inc castors)

Door locks / Door open warning / Digital controller / Digital Temperature Display

4 adjustable shelves / dual vertical interior LED strip light

10 AMP Australian plug

Shipping weight : 150 kg



Halo TGF-23SD

Freezer

RRP \$ 6675 + GST

597litre Freezer with LED lights with Shadow Free Advertising Panel

Triple Pane heated Glass doors with heat reflective film

Rated Temp : -16 to -24c

External : 685W x 770D x 1955H

Internal : 585W x 655D x 1535H

5 shelves standard weight: 175kg 10 Amp plug Available in black or white



Halo TGF-35SD

Slimline Freezer

RRP \$ 9100 + GST

1048 Lt Freezer

Digital Temperature control system

LED Lights

Temperature -16 to -24 degrees

External : 1004W x 809D x 1955H

Weight : 231kg

Available in Black or white

15 Amp Insulated Australian Plug



Halo Freezer Range

Do you have an ABN?
Contact us for a trade discount!



Halo TGF-47SD Freezer

RRP \$ 9855 + GST

1308 litre freezer with Digital Temperature Control

LED lights -16 to -24 degrees

External : 1299 W x 809D x 1956 H

Internal : 1199 W x 699 D x 1535H

10 shelves standard weight : 265 kg 15 Amp plug

Available in Black or White

Halo TGF-72SD Freezer 2019LT Freezer RRP \$13,815 + GST

Digital Temperature control LED lights

Operating temperature : -16 to -24 degrees

External : 1981 W x 809D x 1956 H

15 shelves standard weight : 356 kg 15 Amp plug

Available in Black or White



specialities



 **orford**
REFRIGERATION

Do you have an ABN?
Contact us for a trade discount!

EB36R-Sn-Flower Specifications	Vertical Flower Refrigerator with Illuminated Advertising Sign
Flower Cabinet	Designed to extend the shelf life of fresh flowers
Capacity	1071 Litres (Gross)
Dimensions	1286W x 762D x 2220H
Weight	221Kg
Florist Benefits	Temperature Management for flowers
Colours	Ebony Black, and Snow White
Power Point	220 - 240v 50Hz. (Standard GPO)
Input Current	2.9 Amps
Thermometer	Digital
Shelves	8 Height Adjustable Heavy Duty PVC Coated
Shelves	2 Fixed Stainless Steel Base Shelves
Shelf Adjustment	12mm Increments
Door	2 x Self Closing, Double Glazed Safety Glass, Double Heat reflective Low E, Warm edge
Footings	Heavy Duty Castors, Lockable Front
Interior Light	LED, Automatic and manual control
Refrigerant	R134a
Cabinet Classes	3M1, 4M1, 5M1
MEPS	Compliant (High Efficiency)
* Energy Consumption	4.74 kWh/24h
Condenser Filter	Easy front access
Illuminated Advertis-	200mm High, Top Mounted
Sign Illumination	LED, Automatic and manual control

RRP : \$5193 + GST
Orford EB36R-Sn-A-Flower



Daily running costs based on power costs of .28c per kW

- \$1.20 per day with sign box off
- \$1.33 per day with sign box on

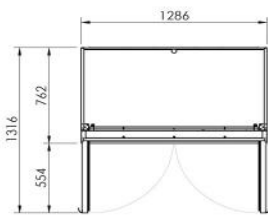

IP Protected by AUS DSN no 345317 & Patent NO 2013100761

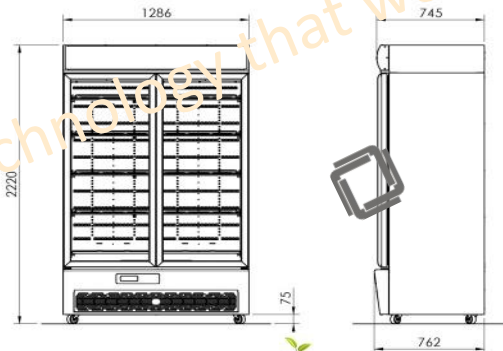

Flower Fridges 4 U

For more information on the Orford Group flower Range including features & benefits refer to

www.flowerfridges4u.com.au



Orford EB Flower Fridges

The Orford Flower Fridge Range now comes in a Rear Loading version.

Position your Flower Fridge next to your counter allowing customers to access from the front doors while you continue to restock from the rear doors

RRP : \$5543 + GST

Orford EB36R-Sn-Flower- Pass Thru



RRP : \$6870 + GST

EB45R-Sn-Flower- Pass Thru



Do you have an ABN?
Contact us for a trade discount!



For more information on the Orford Group flower Range including features & benefits refer to

www.flowerfridges4u.com.au



Do you have an ABN?
Contact us for a trade discount!

EB45R-Sn-Flower Specifications	Vertical Flower Refrigerator with Illuminated Advertising Sign
Flower Cabinet	Designed to extend the shelf life of fresh flowers
Capacity	1384 Litres (Gross)
Dimensions	1640W x 762D x 2220H
Weight	265 Kg
Florist Benefits	Temperature Management for flowers
Colours	Ebony Black, and Snow White
Power Point	220 - 240v 50Hz. (Standard GPO)
Input Current	3.2 Amps
Thermometer	Digital
Shelves	12 Height Adjustable Heavy Duty PVC Coated
Shelves	3 Fixed Stainless Steel Base Shelves
Shelf Adjustment	12mm Increments
Door	3 x Self Closing, Double Glazed Safety Glass, Double Heat reflective Low E, Warm edge
Footings	Heavy Duty Castors, Lockable Front
Interior Light	LED, Automatic and manual control
Refrigerant	R134a
Cabinet Classes	3M1, 4M1, 5M1
MEPS	Compliant (High Efficiency)
* Energy Consumption	6.03 kWh/24h
Condenser Filter	Easy front access
Illuminated Advertising Sign	200mm High, Top Mounted
Sign Illumination	LED, Automatic and manual control

RRP : \$6480 + GST
EB45R-Sn-A-Flower

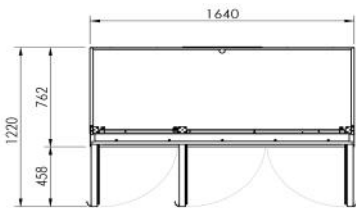

IP Protected by AUS DSN no 345317 & Patent NO 2013100761

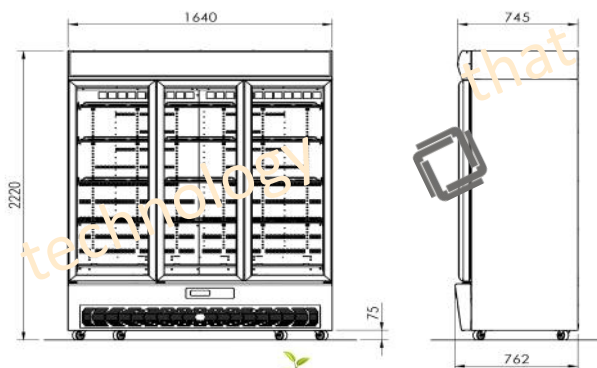

Daily running costs based on power costs of .28c per kW

- \$1.53 per day with sign box off
- \$1.69 per day with sign box on



Flower Fridges 4 U

For more information on the Orford Group flower Range including features & benefits refer to

www.flowerfridges4u.com.au





Economy Wine Range

Do you have an ABN?
Contact us for a trade discount!

FMB20-Sn-Wine	Vertical Display Refrigerator with Illuminated Advertising Sign
Construction	Powder Coated galvanized steel Int / Ext White
Capacity	557Litres (Gross)
Dimensions	740W x 791D x 2200H
Weight	165Kg
Operating Temp	0° - 5° C.
Ambient Temp Range	0° - 40° C.
Power Point	230 - 240v 50Hz. (Standard GPO)
Thermometer	Mechanical
Shelves	4 Height Adjustable Heavy Duty PVC Coated
Shelf Adjustment	12mm Increments
Door	Self Closing, Double Glazed Safety Glass, Argon filled Single Heat reflective Low E, Right Hand hinged.
Footings	Heavy Duty Castors, Lockable Front
Compressor	Danfoss
Interior Light	LED (on/off switch included)
Refrigerant	R134A
Insulation	50mm Polyurethane, CFC, HCFC, HFC Free
Climate Class	Class 5
MEPS	Compliant (High Efficiency)
Condenser Filter	Rear mounted
Illuminated Advertising Sign	200mm High, Top Mounted.
Sign Illumination	LED

Orford FMB20Sn-wine
RRP : \$2745 + GST



FMB30-Sn-Wine	Vertical Display Wine Refrigerator with Illuminated Advertising Sign
Construction	Powder Coated galvanized steel Int/ Ext White
Capacity	889 Litres (Gross)
Dimensions	1130W x 791D x 2200H
Weight	210Kg
Operating Temp	0° - 5° C.
Ambient Temp Range	0° - 40° C.
Power Point	230 - 240v 50Hz. (Standard GPO)
Thermometer	Mechanical
Shelves	8 Height Adjustable Heavy Duty PVC Coated
Shelf Adjustment	12mm Increments
Door	Self Closing, Double Glazed Safety Glass, Argon filled Single Heat reflective Low E, Right Hand hinged.
Footings	Heavy Duty Castors, Lockable Front
Compressor	Danfoss
Interior Light	LED (on/off switch included)
Refrigerant	R134A
Insulation	50mm Polyurethane, CFC, HCFC, HFC Free
Climate Class	Class 5
MEPS	Compliant (High Efficiency)
Condenser Filter	Rear mounted
Illuminated Advertising Sign	200mm High, Top Mounted.
Sign Illumination	LED

Orford FMB30Sn-Wine
RRP : \$3265 + GST





PlanetSmart™ EB Wine Range

Do you have an ABN?
Contact us for a trade discount!

EB20R-Sn-Wine Specifications	Vertical Display Wine Refrigerator with Illuminated Advertising Sign
Construction	Powder Coated galvanized steel Interior / Exterior White
Capacity	595 Litres (Gross)
Dimensions	756W x 762D x 2220H
Weight	155Kg
Operating Temp	0° - 5° C.
Ambient Temp Range	0° - 40° C.
Power Point	220 - 240v 50Hz. (Standard GPO)
Input Current	2.8 Amps
Thermometer	Digital
Shelves	4 Height Adjustable Heavy Duty PVC Coated
Shelves	1 Fixed Stainless Steel Base Shelves
Shelf Adjustment	12mm Increments
Refrigerated Shelf Area	1.42 m ²
Condensate Disposal	Automatic by energy efficient, No Cost, Hot Gas
Door	1 x Self Closing, Double Glazed Safety Glass, Double Heat reflective Low E, Warm edge, R/H
Footings	Heavy Duty Castors, Lockable Front
Interior Light	LED, Automatic and manual control
Refrigerant	R134a
Drier	Solid Core
Insulation	50mm Polyurethane, CFC, HCFC, HFC Free
Cabinet Classes	3M1, 4M1, 5M1
MEPS	Compliant (High Efficiency)
* Energy Consumption	3.43 kWh/24h
Condenser Filter	Easy front access
Illuminated Advertising Sign	200mm High, Top Mounted
Sign Illumination	LED, Automatic and manual control

RRP : \$4035 + GST
Orford EB20R-Sn-A-Wine

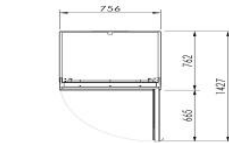

IP Protected by AUS DSN no 345317
& Patent NO 2013100761

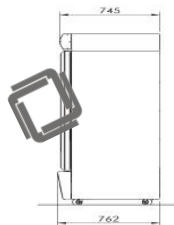
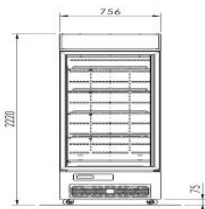

The Orford Group
EB20 Wine Cabinet

Energy Consumption
@3M1 kWh/24hr

EB20R-SN-A with sign

3.43





PlanetSmart™ EB Wine Range

Do you have an ABN?
Contact us for a trade discount!

EB30R-Sn-wine Specifications	Vertical Wine Display Refrigerator with Illuminated Advertising Sign
Construction	Powder Coated galvanized steel Interior /Exterior White
Capacity	895 Litres (Gross)
Dimensions	1094W x 762D x 2220H
Weight	210Kg
Operating Temp	0° - 5° C.
Ambient Temp Range	0° - 40° C.
Power Point	220 - 240v 50Hz. (Standard GPO)
Input Current	2.8 Amps
Thermometer	Digital
Shelves	8 Height Adjustable Heavy Duty PVC Coated
Shelves	2 Fixed Stainless Steel Base Shelves
Shelf Adjustment	12mm Increments
Refrigerated Shelf Area	2.17 m ²
Condensate Disposal	Automatic by energy efficient, No Cost, Hot Gas
Door	2 x Self Closing, Double Glazed Safety Glass, Double Heat reflective Low E, Warm edge
Footings	Heavy Duty Castors, Lockable Front
Interior Light	LED, Automatic and manual control
Refrigerant	R134a
Cabinet Classes	3M1, 4M1, 5M1
MEPS	Compliant (High Efficiency)
* Energy Consumption	4.24 kWh/24h
Condenser Filter	Easy front access
Illuminated Advertising Sign	200mm High, Top Mounted
Sign Illumination	LED, Automatic and manual control

RRP : \$4622 + GST
EB30R-Sn-A-wine



Bar Fridges 4 U
www.barfridges4u.com.au

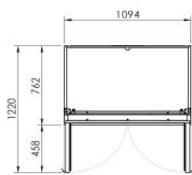

IP Protected by AUS DSN no 345317
& Patent NO 2013100761

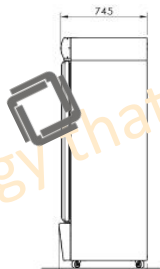
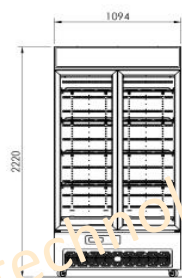

The Orford Group EB Model

Energy Consumption
@3M1 kWh/24hr

EB30R-SN-A with sign

4.24





PlanetSmart™ EB Wine Range

Do you have an ABN?
Contact us for a trade discount!

EB36R-Sn-Wine Specifications	Vertical Wine Refrigerator with Illuminated Advertising Sign
Wine Cabinet	
Capacity	1071 Litres (Gross)
Dimensions	1286W x 762D x 2220H
Weight	221Kg
Florist Benefits	Temperature Management for flowers
Colours	Ebony Black, and Snow White
Power Point	220 - 240v 50Hz. (Standard GPO)
Input Current	2.9 Amps
Thermometer	Digital
Shelves	8 Height Adjustable Heavy Duty PVC Coated
Shelves	2 Fixed Stainless Steel Base Shelves
Shelf Adjustment	12mm Increments
Door	2 x Self Closing, Double Glazed Safety Glass, Double Heat reflective Low E, Warm edge
Footings	Heavy Duty Castors, Lockable Front
Interior Light	LED, Automatic and manual control
Refrigerant	R134a
Cabinet Classes	3M1, 4M1, 5M1
MEPS	Compliant (High Efficiency)
* Energy Consumption	4.74 kWh/24h
Condenser Filter	Easy front access
Illuminated Advertising Sign	200mm High, Top Mounted
Sign Illumination	LED, Automatic and manual control

RRP : \$5193 + GST
EB36R-Sn-A-Wine

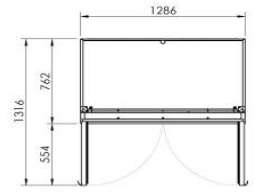

IP Protected by AUS DSN no 345317
& Patent NO 2013100761

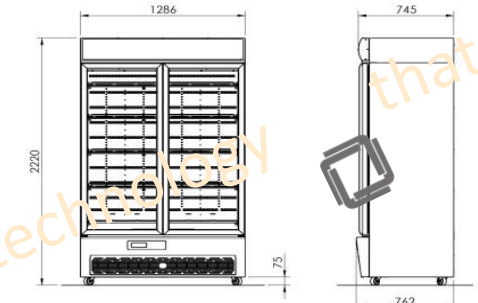

Bar Fridges 4 U
www.barfridges4u.com.au

Daily running costs based on power costs of .28c per kW

- \$1.20 per day with sign box off
- \$1.33 per day with sign box on

For more information on the Orford Group Wine and Bar Range including features & benefits refer to





PlanetSmart™ EB Wine Range

Do you have an ABN?
Contact us for a trade discount!

EB45R-Sn-Wine Specifications	Vertical Wine Refrigerator with Illuminated Advertising Sign
Wine Cabinet	
Capacity	1384 Litres (Gross)
Dimensions	1640W x 762D x 2220H
Weight	265 Kg
Florist Benefits	Temperature Management for flowers
Colours	Ebony Black, and Snow White
Power Point	220 - 240v 50Hz. (Standard GPO)
Input Current	3.2 Amps
Thermometer	Digital
Shelves	12 Height Adjustable Heavy Duty PVC Coated
Shelves	3 Fixed Stainless Steel Base Shelves
Shelf Adjustment	12mm Increments
Door	3 x Self Closing, Double Glazed Safety Glass, Double Heat reflective Low E, Warm edge
Footings	Heavy Duty Castors, Lockable Front
Interior Light	LED, Automatic and manual control
Refrigerant	R134a
Cabinet Classes	3M1, 4M1, 5M1
MEPS	Compliant (High Efficiency)
* Energy Consumption	6.03 kWh/24h
Condenser Filter	Easy front access
Illuminated Advertising Sign	200mm High, Top Mounted
Sign Illumination	LED, Automatic and manual control

RRP : \$6480 + GST
EB45R-Sn-A-Wine



Daily running costs based on power costs of .28c per kW

- \$1.53 per day with sign box off
- \$1.69 per day with sign box on

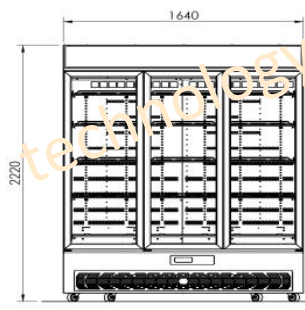
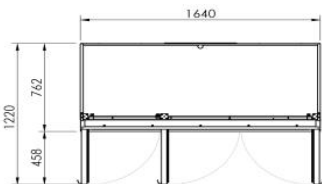

IP Protected by AUS DSN no 345317
Patent NO 2013100761

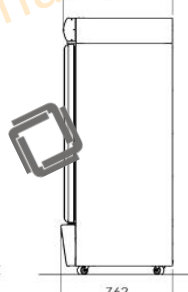

Bar Fridges 4 U
www.barfridges4u.com.au

For more information on the Orford Group Bar and Wine Range including features & benefits refer to



Do you have an ABN?
Contact us for a trade discount!

EB30R-CC-Sn Specifications	Vertical Display Choc Refrigerator with Illuminated Advertising Sign
Construction	Powder Coated galvanized steel Interior /Exterior White
Capacity	895 Litres (Gross)
Dimensions	1094W x 762D x 2220H
Weight	210Kg
Operating Temp	12° - 18° C.
Ambient Temp Range	0° - 40° C.
Power Point	220 - 240v 50Hz. (Standard GPO)
Input Current	2.8 Amps
Thermometer	Digital
Shelves	8 Height Adjustable Heavy Duty PVC Coated
Shelves	2 Fixed Stainless Steel Base Shelves
Shelf Adjustment	12mm Increments
Refrigerated Shelf Area	2.17 m ²
Condensate Disposal	Automatic by energy efficient, No Cost, Hot Gas
Door	2 x Self Closing, Double Glazed Safety Glass, Double Heat reflective Low E, Warm edge
Footings	Heavy Duty Castors, Lockable Front
Interior Light	LED, Automatic and manual control
Refrigerant	R134a
Cabinet Classes	3M1, 4M1, 5M1
MEPS	Compliant (High Efficiency)
* Energy Consumption	4.24 kWh/24h
Condenser Filter	Easy front access
Illuminated Advertising Sign	200mm High, Top Mounted
Sign Illumination	LED, Automatic and manual control

RRP : \$4622 + GST

EB30CC-Sn

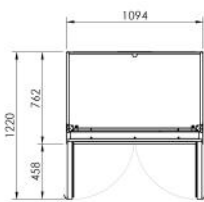

IP Protected by AUS DSN no 345317
& Patent NO 2013100761

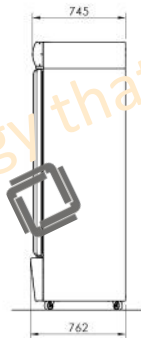
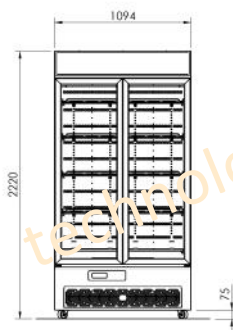

The Orford Group EB Model

Energy Consumption
@3M1 kWh/24hr

EB30R-A 3.78

EB30R-SN-A with illuminated sign 4.24

For more information on the Orford Refrigeration Chocolate Fridge Range including features & benefits refer to

www.orford.com.au



Do you have an ABN?
Contact us for a trade discount!

EB36R-CC-Sn Specifications	Vertical Display Choc Refrigerator with Illuminated Advertising Sign
Construction	Powder Coated galvanized steel Interior /Exterior White
Capacity	1071 Litres (Gross)
Dimensions	1286W x 762D x 2220H
Weight	221Kg
Operating Temp	12° - 18° C.
Ambient Temp Range	0° - 40° C.
Power Point	220 - 240v 50Hz. (Standard GPO)
Input Current	2.9 Amps
Thermometer	Digital
Shelves	8 Height Adjustable Heavy Duty PVC Coated
Shelves	2 Fixed Stainless Steel Base Shelves
Shelf Adjustment	12mm Increments
Door	2 x Self Closing, Double Glazed Safety Glass, Double Heat reflective Low E, Warm edge
Footings	Heavy Duty Castors, Lockable Front
Interior Light	LED, Automatic and manual control
Refrigerant	R134a
Drier	Solid Core
Insulation	50mm Polyurethane, CFC, HCFC, HFC Free
Cabinet Classes	3M1, 4M1, 5M1
MEPS	Compliant (High Efficiency)
* Energy Consumption	4.74 kWh/24h
Condenser Filter	Easy front access
Illuminated Advertising Sign	200mm High, Top Mounted
Sign Illumination	LED, Automatic and manual control

RRP : \$5193 + GST
EB36CC-Sn

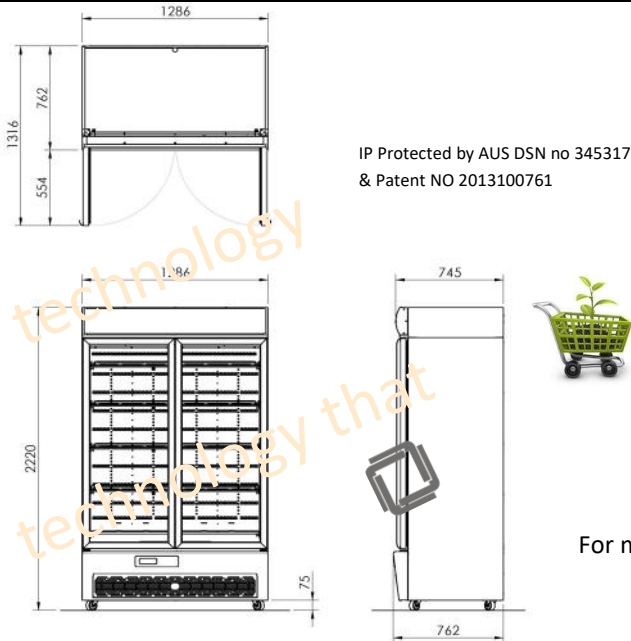

The Orford Group EB Model	Energy Consumption @3M1 kWh/24hr
EB36R-A	4.28
EB36R-SN-A with illuminated sign	4.74

For more information on the Orford Refrigeration Chocolate Fridge Range including features & benefits refer to

www.orford.com.au



Do you have an ABN?
Contact us for a trade discount!

EB45R-Sn Specifications	Vertical Display Refrigerator with Illuminated Advertising Sign
Construction	Powder Coated galvanized steel Interior / Exterior White
Capacity	1384 Litres (Gross)
Dimensions	1640W x 762D x 2220H
Weight	265 Kg
Operating Temp	12° - 18° C.
Ambient Temp Range	0° - 40° C.
Power Point	220 - 240v 50Hz. (Standard GPO)
Input Current	3.2 Amps
Thermometer	Digital
Shelves	12 Height Adjustable Heavy Duty PVC Coated
Shelves	3 Fixed Stainless Steel Base Shelves
Shelf Adjustment	12mm Increments
Refrigerated Shelf Area	3.38 m ²
Condensate Disposal	Automatic by energy efficient, No Cost, Hot Gas
Door	3 x Self Closing, Double Glazed Safety Glass, Double Heat reflective Low E, Warm edge
Footings	Heavy Duty Castors, Lockable Front
Interior Light	LED, Automatic and manual control
Refrigerant	R134a
Cabinet Classes	3M1, 4M1, 5M1
MEPS	Compliant (High Efficiency)
* Energy Consumption	6.03 kWh/24h
Condenser Filter	Easy front access
Illuminated Advertising Sign	200mm High, Top Mounted
Sign Illumination	LED, Automatic and manual control

RRP : \$6480 + GST
EB45CC-Sn

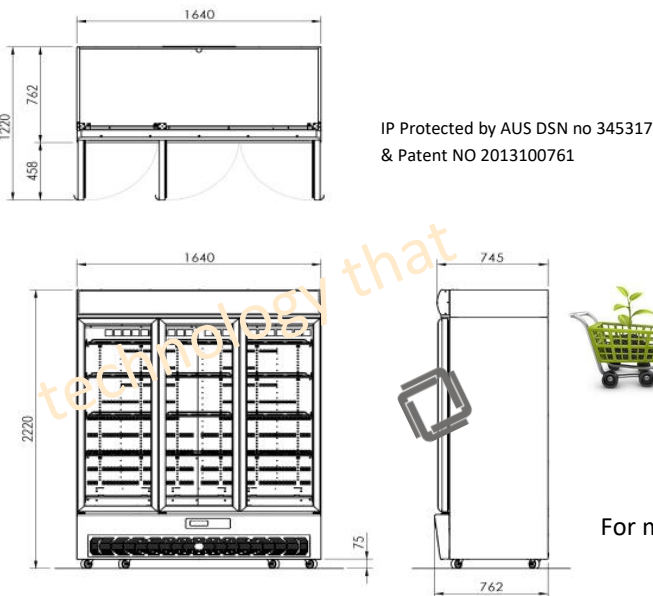

The Orford Group EB Model	Energy Consumption @3M1 kWh/24hr
EB45R-A	5.45
EB45R-SN-A with illuminated sign	6.03

For more information on the Orford Refrigeration Chocolate Fridge Range including features & benefits refer to

www.orford.com.au



Café & Cake Range



Orford CDR1200

Introducing the
ORFORD Cake Fridge
& Freezer Café Range



Orford CDR1500



Orford CDF1200

Do you have an ABN?
Contact us for a trade discount!



Do you have an ABN?
Contact us for a trade discount!

CDR1200-2 Specifications	Cake Display—Tower Style
Construction	Stainless Steel—internal / external
Capacity	850 Litres (Gross)
Dimensions	1200 W x 750 D x 1350 H (mm)
Weight	310 Kg (net)
Operating Temp	2° to 8° C.
Ambient Temp Range	0° - 32° C.
Power Point	220 - 240v 50Hz. (Standard GPO)
Input Current	6.3 Amps
Thermometer	Digital
Shelves	2 Height Adjustable Heavy Duty
Refrigerated Shelf Area	2.62 m ²
Rear Door	2 x sliding doors
Footings	Heavy Duty Castors, Lockable Front
Interior Light	LED
Refrigerant	R134a
Drier	Solid Core
Insulation	60mm Polyurethane, CFC, HCFC, HFC Free

Orford CDR1200 Cake Fridge

RRP : \$5248 + GST



Display cakes beautifully in the Orford cake fridge

www.orford.com.au

sales@orford.com.au

1300 673 673

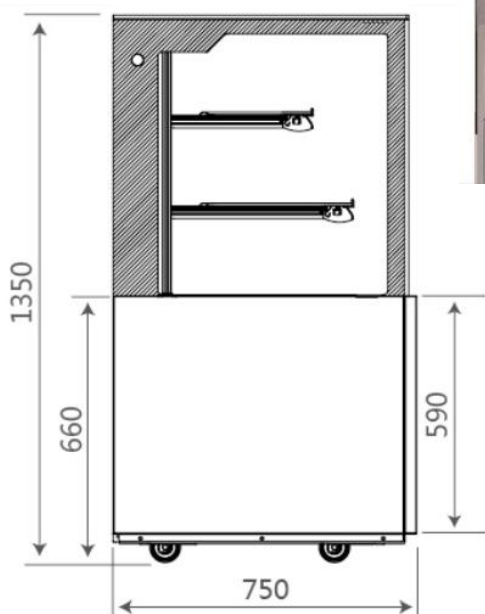

Do you have an ABN?
Contact us for a trade discount!

CDR1500-2 Specifications	Cake Display—Tower Style
Construction	Stainless Steel—internal / external
Capacity	850 Litres (Gross)
Dimensions	1500 W x 750 D x 1350 H (mm)
Weight	250 Kg (net)
Operating Temp	+2° to +8° C.
Ambient Temp Range	0° - 32° C.
Power Point	220 - 240v 50Hz. (Standard GPO)
Input Current	6.3 Amps
Thermometer	Digital
Shelves	2 Height Adjustable Heavy Duty
Refrigerated Shelf Area	2.62 m ²
Rear Door	2 x sliding doors
Footings	Heavy Duty Castors, Lockable Front
Interior Light	LED
Refrigerant	R134a
Drier	Solid Core
Insulation	60mm Polyurethane, CFC, HCFC, HFC Free

Orford CDR1500 Cake Fridge

RRP : \$6119 + GST



Display cakes beautifully in the Orford cake fridge

www.orford.com.au

sales@orford.com.au

1300 673 673

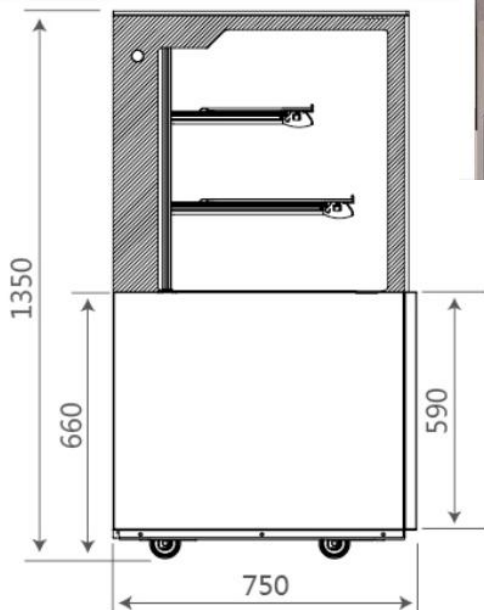

Do you have an ABN?
Contact us for a trade discount!

<i>CDF1200</i> Specifications	Cake & Gelato Display Freezer
Construction	Stainless Steel—internal / external
Capacity	850 Litres (Gross)
Dimensions	1200 W x 800 D x 1200 H (mm)
Weight	250 Kg (net)
Operating Temp	-16° to -25° C.
Ambient Temp Range	0° - 32° C.
Power Point	220 - 240v 50Hz. (Standard GPO)
Input Current	6.3 Amps
Thermometer	Digital
Shelves	2 Height Adjustable Heavy Duty
Shelf Adjustment	12mm Increments
Refrigerated Shelf Area	2.62 m ²
Condensate Disposal	Automatic by energy efficient, No Cost, Hot Gas
Rear Door	2 x sliding doors
Footings	Heavy Duty Castors, Lockable Front
Interior Light	LED light
Refrigerant	R404a
Drier	Solid Core
Insulation	60mm Polyurethane, CFC, HCFC, HFC Free

Orford CDF1500 Cake Freezer

RRP : \$9799 + GST



Display frozen cakes and ice cream cakes

www.orford.com.au

sales@orford.com.au

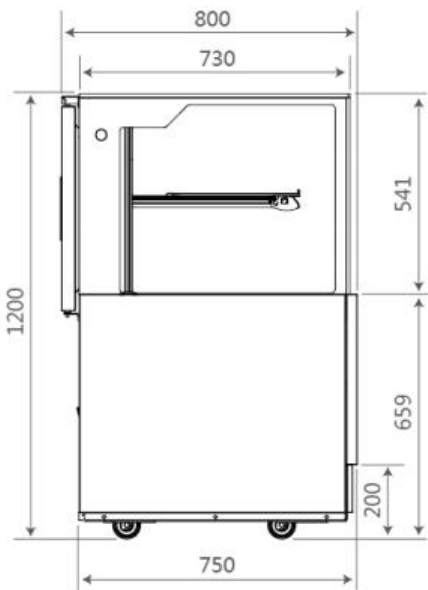



Halo Cake & Café Range

Do you have an ABN?

Contact us for a trade discount!

Halo KK1200-640 RRP 5400 + GST

Dims : 1200 w x 680 d x 1350 h (mm)

Temp : +2 to+8 c Capacity : 510L

Dixell controller, EBM condenser fan, Ambient 32 deg at 82% RH.

White LED light under each adjustable shelf

3 shelves plus base shelf

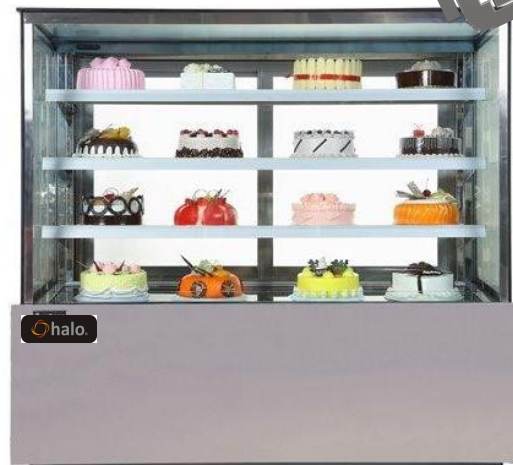

Halo KK1500-650 RRP \$6225 + GST

Dims : 1500 w x 680 d x 1350 h (mm)

Temp : +2 to+8 c Capacity : 510L

Dixell controller, EBM condenser fan,

Ambient 32 deg at 82% RH.

White LED light under each adjustable shelf

3 shelves plus base shelf



ORFORD REFRIGERATION





VB36L-Sn-IM ICE Freezer

Do you have an ABN?
Contact us for a trade discount!

VB36L-Sn-A-Ice Specifications	Vertical Display Ice Freezer with Illuminated Advertising Sign
Construction	Powder Coated galvanized steel Interior /Exterior White
Capacity	1071 Litres (Gross)
Dimensions	1286W x 866 D (+82 overhang = 952mm total) x 2215H (mm)
Weight	250 Kg (net)
Operating Temp	-19° to -23° C.
Ambient Temp Range	0° - 40° C.
Power Point	220 - 240v 50Hz. (15AMP power outlet)
Input Current	6.3 Amps
Thermometer	Digital
Shelves	8 Height Adjustable Heavy Duty PVC Coated
Shelves	2 Fixed Stainless Steel Base Shelves
Shelf Adjustment	12mm Increments
Refrigerated Shelf Area	2.62 m ²
Condensate Disposal	Automatic by energy efficient, No Cost, Hot Gas
Full Handled Door	2 x Self Closing, Triple Glazed Safety Glass, Argon filled with Double Heat reflective Low E, Warm edge with removable torsion bar, heated frame
Footings	Heavy Duty Castors, Lockable Front
Interior Light	LED, Automatic and manual control
Refrigerant	R404a
Drier	Solid Core
Insulation	60mm Polyurethane, CFC, HCFC, HFC Free
Cabinet Classes	3L1, 4L2, 5L3 up to 40 degree Celsius ambient
MEPS	Compliant (High Efficiency)
* Energy Consumption	20.73 kWh/24h/m2
Condenser Filter	Easy front access
Illuminated Advertising Sign	205mm High, Top Mounted
Sign Illumination	LED, Automatic (motion sensor control) and manual control
Temperature Alarms	High and low temperature alarms
HACCP Function	Alarm system
Defrost	Energy Efficient Hot Gas
Sign Illumination	LED, Automatic and manual control

Orford VB36LSn—IM ICE Freezer

RRP : \$ 8885 + GST

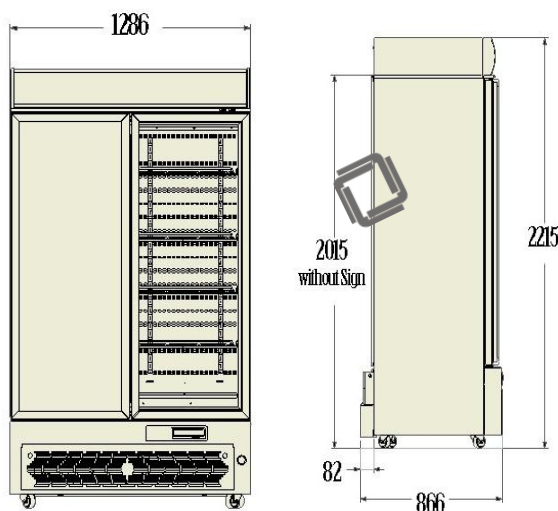

The Orford Group VB Freezer Model	Energy Consumption @31L kWh/24hr
VB36L-Sn-IM	20.73

Maximise Ice Sales with the Orford Bottom Mount Ice Freezer with a removable package.

Matches the Orford EB Range

100% designed by the Orford Engineering Team

Patent Protected in Australia & New Zealand

www.orford.com.au





under bench
/bar series



Do you have an ABN?
Contact us for a trade discount!



Alfresco Dining with ORFORD

The Orford Back Bar Cooler Range

The perfect choice for your Alfresco area. The cabinets can be built fully into your cabinet or wall cavity

Energy efficient. Outdoor rated, tested to 32 degrees

The Orford Back Bar Range is part of the Orford

PlanetSmart Range—saving the planet one fridge at a time



Orford BB135 Single Door Back Bar \$2010 + GST

Outdoor Glass Door Bar Fridge

Energy Efficient Stainless Steel Interior & Exterior

Dims: 600mm w x 500 d (+45mm handle) x 865 h Weight 55kg

Capacity : 135 Litres

Low E Glass Doors, LED Interior lighting, EBM fans, Carel Eco Controller, Heated Door Mullion

Orford BB210 Double Door Back Bar \$2480 + GST

Outdoor Glass Door Bar Fridge

Energy Efficient Stainless Steel Interior & Exterior

Dims: 900mm w x 500 d (+45mm handle) x 865 h

Capacity : 210 Litres

Low E Glass Doors, LED Interior lighting, EBM fans, Carel Eco Controller, Heated Door Mullion



Do you have an ABN?
Contact us for a trade discount!



Orford Back Bars
Alfresco dining just got
better



Body Finish : 304 Stainless
Interior Finish : Polished 304 Mirror Stainless
Door Finish : 304 Stainless
Door Mullion : Heated
Door Hinged : Self Closing
Door Opened Depth : 910mm
Decibel rating : 50
Double Glazed tempered door. Low E glass
Can operate in 40 degrees ambient
Famous parts : Carel Eco controllers, EBM fans,
Embraco compressor
Door Locks

Lockable : Yes
Lighting : LED lights
Adjustable Feet : Yes (4)
Shelves : 2 x flat chromed adjustable shelves per
door
MEPS compliant
CTick compliant
IP34 Outdoor rated
Allow 5 - 10 mm Shadowline when building into
cabinetry
Low E Glass Doors



Orford BB325 Triple Door Back Bar \$3465 + GST

Outdoor Glass Door Bar Fridge

Energy Efficient Stainless Steel Interior & Exterior

Dims: 1350mm w x 500 d (+45mm handle) x 865 h

Capacity : 325 Litres

Low E Glass Doors, LED Interior lighting, EBM fans, Carel Eco
Controller, Heated Door Mullion



Do you have an ABN?
Contact us for a trade discount!



Orford Back Bars
Alfresco dining just got better



Model	H mm	W mm	D mm	Gross Weight KGs	Refrigerant	Shelves	Capacity litres	330ml Bottles	Power Consumption (at 25 de- grees ambient)
BB135	865	600	500 +45mm handle	55	R600a	2	135	104	1.93Kwh/24hrs
BB210	865	900	500 + 45mm handle	69	R600a	4	210	169	2.68Kwh/24hrs
BB325	865	1350	500 + 45mm handle	90	R600a	6	325	260	4.22Kwh/24hrs



Door locks standard



ebmpapst

German brand EBM fan motors for reliable service





Halo KUR Refrigerator

Do you have an ABN?
Contact us for a trade discount!



Halo KUR9-1 REFRIGERATOR RRP \$3115 + GST

Undercounter Refrigerator — 198 litres All stainless steel 304

Left hand side Embraco Compressor, EBM Fan

Temperature Range : 1c to 6c degrees 1 shelf, weight 72 kg
Refrigerant 134A LED Digital Display Soft Touch Controller

Dimensions : 900 w x 700 d x 850 h (mm) On castors. 10 Amp plug

Halo KUR12-2 Undercounter Fridge RRP \$3415 + GST

Embraco compressor, EBM fan Capacity 311 Litre

Temperature Range 0c to 8c, 70mm insulation

Refrigerant Gas : R134a 2 shelves, 3 Amps, input power 314w,
Weight 84kg LED Digital Display and soft touch controller

Dims : 1200 w x 700 d x 850 h (mm) On castors 10Amp plug



Halo KUR15-2 Undercounter Fridge RRP \$3900 + GST

Embraco compressor, EBM fan Capacity 425 Litre

Temperature Range 0c to 8c, Refrigerant Gas : R134a

2 shelves, 3 Amps, input power 314w, Weight 93kg

LED Digital Display and soft touch controller

Dims : 1500 w x 700 d x 850 h (mm) On castors 10Amp plug

Halo KUR18-3 Undercounter Fridge RRP \$4200 + GST

Embraco compressor, EBM fan Capacity 538 Litre

Temperature Range 0c to 8c, Refrigerant Gas : R134a

3 shelves, 4.4 Amps, input power 366w, Weight 109kg

LED Digital Display and soft touch controller

Dims : 1800 w x 700 d x 850 h (mm) On castors 10Amp plug



ORFORD REFRIGERATION





Halo KUF Freezer

Do you have an ABN?
Contact us for a trade discount!



Halo KUF9-1 FREEZER

RRP \$ 3375 + GST

Undercounter freezer—198 litres

All stainless steel 304

Left hand side Embraco Compressor,

EBM Fan Temp Range : -21c to -12 degrees 1 shelf, weight 72 kg

Refrigerant R404a LED Digital Display and Soft Touch Controller

Dimensions : 900 w x 700 d x 850 h (mm) On castors. 10 Amp plug

Halo KUF12-2 Undercounter Freezer RRP \$3710 + GST

Embraco compressor, EBM fan Capacity 311 Litre

Temperature Range : -21c to -12 degrees, 70mm insulation

Refrigerant Gas : R404a 2 shelves, 3 Amps, input power 366w, Weight 84kg

LED Digital Display and soft touch controller

Dims : 1200 w x 700 d x 850 h (mm) On castors



Halo KUF15-2 Undercounter Freezer RRP \$4100 + GST

Embraco compressor, EBM fan Capacity 425 Litre

Temperature Range : -21c to -12 degrees, 70mm insulation

Refrigerant Gas : R404a

2 shelves, 3 Amps, input power 366w, Weight 84kg

LED Digital Display and soft touch controller

Dims : 1500 w x 700 d x 850 h (mm) On castors

Halo KUF18-3 Undercounter Freezer RRP \$4800 + GST

Embraco compressor, EBM fan Capacity 538 Litre

Temperature Range : -21c to -12 degrees, 70mm insulation

Refrigerant Gas : R404a

3 shelves, 4.4 Amps, input power 613w, Weight 109kg

LED Digital Display and soft touch controller Dims : 1800 w x 700 d x 850 h (mm)





Halo KURF Combos

Do you have an ABN?
Contact us for a trade discount!

Halo KURF12-2 Fridge / Freezer Combo RRP \$4500 + GST

Dual temperature 2 Door Undercounter

Freezer Capacity 134 Litre Temp Range -21c to -12c, Gas : 404a

Fridge capacity 136 Litre Temp Range 1c to 5c Gas : 134a

2 doors, 1 shelf per door, 3 Amps, input power 316 w, Weight 87kg

Dims : 1200 w x 700 d x 850 h (mm) On castors



Halo KURF15-2 Fridge / Freezer Combo RRP \$4700 + GST

Dual temperature 2 Door Undercounter

Freezer Capacity 177 Litre Temp Range -21c to -12c, Gas : 404a

Fridge capacity 189 Litre Temp Range 1c to 5c Gas : 134a

2 doors, 1 shelf per door, 3 Amps, input power 316 w, Weight 96kg

Dims : 1500 w x 700 d x 850 h (mm) On castors



Halo KURF18-3 Fridge / Freezer Combo RRP \$4900 + GST

Dual temperature 3 Door Undercounter

Freezer Capacity 151 Litre Temp Range -21c to -12c, Gas : 404a

Fridge capacity 314 Litre Temp Range 1c to 5c Gas : 134a

3 doors, 1 shelf per door, 4.4 Amps, input power 366 w, Weight 112kg

Dims : 1800 w x 700 d x 850 h (mm) On castors



Orford
REFRIGERATION





Halo KGR Refrigerator

Do you have an ABN?
Contact us for a trade discount!



Halo KGR9-1 Glass Door Refrigerator RRP \$3245 + GST

1 Door Undercounter Refrigerator

Digital display and control

Capacity 137Litre Temp Range 1c to 5c Gas : 134a

1 door with LOW E glass, 1 shelf, Weight 80kg

Dims : 900 w x 700 d x 850 h (mm) On castors 10 Amp plug

Halo KGR12-2 Glass Door Refrigerator RRP \$3850 + GST

2 Door Undercounter Refrigerator Digital display and control

Capacity 311 Litre Temp Range 1c to 5c Gas : 134a

2 doors with LOW E glass, 2 shelf, Weight 96kg

Dims : 1200 w x 700 d x 850 h (mm) On castors 10Amp plug



Halo KGR15-2 Glass Door Refrigerator RRP \$4320 + GST

2 Door Undercounter Refrigerator

Digital display and control

Capacity 425 Litre Temp Range 1c to 5c Gas : 134a

2 doors with LOW E glass, 2 shelf, Weight 96kg

Dims : 1500 w x 700 d x 850 h (mm) On castors 10Amp plug

Halo KGR18—3 Glass Door Refrigerator RRP \$4975 + GST

3 Door Undercounter Refrigerator Digital display and control

Capacity 538 Litre Temp Range 1c to 5c Gas : 134a

3 doors with LOW E glass, 3 shelf, Weight 127kg

Dims : 1800 w x 700 d x 850 h (mm) On castors 10Amp plug



ORFORD
REFRIGERATION





Economy Underbench Refrigerators

Do you have an ABN?
Contact us for a trade discount!

Halo AUR12-2 311 Lt Underbench Fridge

RRP \$2735 + GST

304 Stainless steel Left hand side Embraco compressor
EBM Fan 2 Shelves Temp Range 0—8°C 70 mm insulation
Refrigerant R134 Amps 2.5 Input power 314w Weight 84kg
LED Digital Display and soft touch controller Internal light
Dims : 1200w x 700d x 850h mm On Castors 10Amp plug



Halo AUR15-2 425 Lt Underbench Fridge

RRP \$3175 + GST

304 Stainless steel Left hand side Embraco compressor
EBM Fan 2 Shelves Temp Range 0—8°C 70 mm insulation
Refrigerant R134a Amps 2.5 Input power 314w Weight 93kg
LED Digital Display and soft touch controller Internal Light
Dims : 1500w x 700d x 850h mm On Castors 10Amp plug



Halo AUR18-3 538 Lt Underbench Fridge

RRP \$3495 + GST

304 Stainless steel Left hand side Embraco compressor
EBM Fan 3 Shelves Temp Range 0—8°C
70 mm insulation Refrigerant R134a Amps 3.0
Input power 366w Weight 109 kg
LED Digital Display and soft touch controller
Dims : 1800w x 700d x 850h mm On Castors
Internal light 10Amp plug



ORFORD
REFRIGERATION





Economy Underbench Freezers

Do you have an ABN?
Contact us for a trade discount!



Halo AUF 12-2 311 Lt Underbench Freezer RRP \$2995 + GST

304 Stainless steel Left hand side Embraco compressor
EBM Fan 2 Shelves Temp Range -21°C to -12°C
70 mm insulation Refrigerant R404a Amps 3
Input power 366w Weight 84kg Internal Light
LED Digital Display and soft touch controller On Castors
Dims : 1200w x 700d x 850h mm 10Amp plug

Halo AUF 15-2 425 Lt Underbench Freezer RRP \$3385 + GST

304 Stainless steel Left hand side Embraco compressor
EBM Fan 2 Shelves Temp Range -21°C to -12°C
70 mm insulation Refrigerant R404a Amps 3
Input power 366w Weight 93kg On Castors
LED Digital Display and soft touch controller 10Amp plug
Dims : 1500w x 700d x 850h mm Internal light



Halo APT 93 Pizza Fridge RRP \$7,855 + GST

Temp Range 1 to 5°C Refrigerant R134a
Amps 3.8 Input power 660 w Weight 262 kg
Thermostat control Fan Cooling Type
6 shelves, 12 pans, 3 hood Air Over Pans 10Amp plug
Dims : 2362 w x 820 d x 914 h mm (1069mm with castors)





food
service



Do you have an ABN?
Contact us for a trade discount!

Halo TOG KRF 25-2 Dual Temp Fridge / Freezer RRP \$5,090 + GST

Stainless Steel top Mount Dual Temperature

Fridge with Freezer

Two compressor system

Capacity in litres - Freezer 242 litres / Fridge 222 litres = 664 litres

Temperature: Fridge 1c to 8c

Freezer : -21c to -12c

2 shelves (1 per door)

Weight : 85kg

Fridge—R-134A 3.5 amps power 366, 10amp plug

Dimensions : 640 W x 800 D x 1926 H (including castors) Weight : 150kg

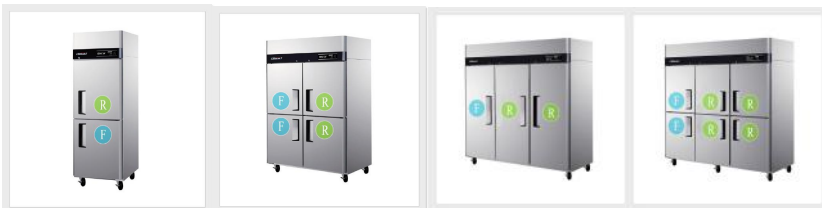

Halo TOG KRF 45-2 Dual Temp Fridge / Freezer RRP \$7135 + GST

Stainless Steel top Mount Dual Temperature

Fridge with Freezer

Two compressor system

Capacity in litres - Freezer 464 litres / Fridge 645 litres = 1109 litres

Blue—Freezer, Green—Fridge

6 shelves (3 per door)

Temperature—Fridge 2c to 6c

Freezer: -21c to -12c 6 shelves

Fridge—R-134A 4.4amps power—w673, 15amp insulated Australian plug

Dimensions : 1260W x 800D x 1935H (including castors) Weight : 150kg

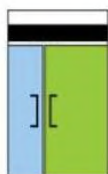



Do you have an ABN?
Contact us for a trade discount!

Halo TOG KRF 45-4 Dual Temp Fridge / Freezer RRP \$7650 + GST

Stainless Steel top Mount Dual Temperature

Fridge with Freezer Two compressor system

Capacity in litres - Freezer 464 litres / Fridge 642 litres = 1106 litres

Blue—Freezer, Green—Fridge

Temperature—Fridge 2c to 6c Freezer— -21c to -12c

6 shelves (3 per door)

Fridge—R-134A 4.4amps power—w673, 15amp insulated Australian plug Dimensions : 1260W x 800D x 1935H (including castors)

Weight : 150kg



**Halo TOG KDU65-3 Dual Temp Fridge / Freezer
RRP \$8815 + GST**

Stainless Steel top Mount Dual Temperature Two compressor system

Capacity in litres - Freezer 555 litres / Fridge 1275 litres = 1830 lts

Blue—Freezer, Green—Fridge

Temperature—Fridge 2c to 6c Freezer— -21c to -12c

9 shelves (3 per door)

Fridge—R-134A 4.4amps power—w673, 15amp insulated Australian plug

Dims : 1900W x 800D x 1935H (including castors) Wt : 175kg

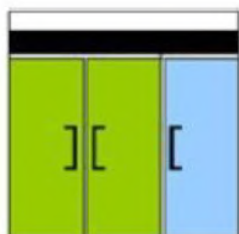



Do you have an ABN?
Contact us for a trade discount!



Model	Temp	Doors	Net Volume	Shelves	Dimensions	Power 220v 50Hz	Shipping Weight
Halo KR25-1	Refrigerator 1~ 8 degrees	1	574	3	640w x 850d x 1926h	314w	115
Halo KF25-1	Freezer -21 ~ -12 degrees	1	574	3	640w x 850d x 1926h	496w	120
Halo KR45-2	Refrigerator 1 ~ 8 degrees	2	1215	6	1260w x 850d x 1926h	366w	190
Halo KF45-2	Freezer -21~ -12 degrees	2	1215	6	1260w x 850d x 1926h	774w	200
Halo KR65-3	Refrigerator 1—8 degrees	3	1876	9	1900w x 850d x 1926h	732w	280
Halo KF65-3	Freezer -21 ~ 12 degrees	3	1876	9	1900w x 850d x 1926h	1346w	280

Note : the depth includes 50mm for the rear condensate tray



halo®



Do you have an ABN?

Contact us for a trade discount!



The K Series Features

- Designed to 40 Degrees ambient operating temperature
- Requires one standard power point : - 240V 50Hz 10 amp
- Digital Temperature Display
- 3 height adjustable shelves per door. Individual shelves behind each door maximize storage configurations
- Stainless steel construction for superior corrosion resistance
- Stainless steel internal floor with coved corners allows for easy cleaning and sanitizing
- Large castors for ease of cabinet movement
- Solid lockable doors. Designed with recessed handle and self closing hinging with 90 degree dwell feature
- LED interior lighting
- One piece door gaskets, removable without tools for easy cleaning
- Automatic energy efficient hot gas condensate disposal. No drainage required
- Internal Pressure release valve

Orford
REFRIGERATION





Do you have an ABN?
Contact us for a trade discount!



Halo KR25-1 574 litre Refrigerator
RRP \$3595 + GST

Stainless Steel Top Mount Single door refrigerator, 574 litre
 Ventilated Cooling Temp Range : 1c to 8c
 Digital Controller and Display 3 Adjustable shelves
 Refrigerant R-134a Amps 3.5 Power - W366 10 Amp
 Dimensions: 640 W x 850 D x 1926 H (Including Castors) Weight—80kg



Halo KR45 -2R Refrigerator 1215 litre RRP \$4905 + GST

Stainless Steel Top Mount 2 door refrigerator, Volume 1215 litres
 Temp Range : 1 degree to 8 degrees 3 Adjustable shelves per Door
 Digital controller and Display Refrigerant R-134a
 10 Amp Australian Plug
 Dimensions W 1260 x D 850 x H 1926 mm Including castors Weight- 142



Halo KR65-3R 3 Door Refrigerator 1876 litre RRP \$7470 + GST



3 Door Top Mount Refrigerator Volume : 1876 litres
 Stainless Exterior & Interior
 3 Adjustable Shelves per Door
 Refrigerant R-134a
 Fan Cooling Type
 Digital Control and Display
 Temp Range 1 degree to 8 degrees Weight 167KG
 W 1900 x D 800 x H 1926 mm Including the castors
 D830mm inc Evaporator Tray H2106 Inc castors
 15 Amp Australian Plug





Do you have an ABN?
Contact us for a trade discount!



Halo KR25-1G Refrigerator 574 litre RRP \$4215 + GST

Stainless Steel 1 door top mount refrigerator with lockable glass display door

Temperature range 0c—8c 6 shelves Refrigerant R-134a 3.5 Amps, Power 366w

Dimensions : 640 w x 850 d x 1926 h mm (including castors)

Weight : 87 kg Lockable castors 240v / 50hz 10 Amp Australian plug

Energy consumption 5.51 kWh / 24 hr



Halo KR45 -2G Refrigerator 1215 litre RRP \$6075 + GST

Stainless Steel 2 door top mount refrigerator with 1215 litre capacity

Glass doors with key lock Soft touch controller

Door open warning Digital temperature display

Temperature range : 0 c to 8 c Refrigerant : R134a

3 shelves per door plus base

Dimensions : 1260w x 850d 1926h mm (incl castors) Weight 152kg

Energy consumption 9.65 kWh / 24 hr



Halo KR65-3G 3 Door Fridge 1876 litre RRP \$8795 + GST

Stainless steel interior and exterior

Glass doors with key lock soft touch controller

Door open warning Digital temperature display,

3 shelves per door plus base internal lighting

Temperature range : 0c to 8c

Dimensions : 1900w x 850d x 1926h (incl castors) Weight : 177kg

Energy consumption 9.65 kWh / 24 hr





Do you have an ABN?
Contact us for a trade discount!



Halo KR25-2G 2 Half Door Fridge 572 litre
RRP \$4630 + GST

Stainless steel interior & Exterior Glass doors with key lock
Soft touch controller Door open warning Digital temperature display
3 shelves per door plus base Internal lighting Temperature range : 0c to 8c
Dimensions : 640 w x 800d x 1926h (incl lockable castors) Weight : 177g
Running Current 6 Amps, input Power 732w
Energy consumption 12.89 kWh / 24 hrs

Halo KR45-4G 4 Half Door Fridge 1210 litre RRP
\$6655 + GST

Stainless steel interior and exterior Glass doors with key lock
Soft touch controller Door open warning
Digital temperature display 3 shelves per door plus base
Internal lighting Temperature range : 0c to 8c
Dimensions : 1260w x 850d x 1926h (incl castors)
Weight : 152kg Energy consumption 9.65 kWh / 24 hr



Halo KR65-6G 6 Half Door Fridge 1868 litre RRP \$10200 + GST

Stainless steel interior and exterior Glass doors with key lock
soft touch controller Door open warning
Digital temperature display, 3 shelves per door plus base
Internal lighting Temperature range : 0c to 8c
Dimensions : 1900 w x 850d x 1926h (incl lockable castors)
Weight : 177g
Running Current 6 Amps, input Power 732w
Energy consumption 12.89 kWh / 24 hrs





Do you have an ABN?
Contact us for a trade discount!



Halo KF25-1F Freezer 574 litre RRP \$4050 + GST

Stainless Steel Top Mount Single door freezer,
 Ventilated Cooling Temp Range -12c to -25c
 Digital Controller and Display 3 Adjustable shelves
 Refrigerant R-404a Amps 3.5 Power - W496 10 Amp
 Dimensions: 640 W x 850 D x 1926 H (Including Castors)
 Weight—80kg Energy consumed 16.45 kWh / 24 hrs
 Rated at 40 degree ambient

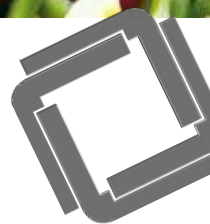

Halo KF45 -2F Freezer 1215 litre RRP \$6295 + GST

Stainless Steel Top Mount 2 door freezer, Temp Range -12c to -21c
 3 Adjustable shelves per Door Digital controller and Display
 Refrigerant R-404a Amps 5.3, Power W774 10 Amp Australian Plug
 Dimensions W 1260 x D 850 x H 1926 mm Including castors
 Weight- 142 kg



Halo KF65-3F 3 Door Freezer 1876 litre RRP \$9090 + GST



3 Door Top Mount Freezer Volume : 1876 litres
 Stainless Exterior & Interior 3 Adjustable Shelves per Door
 Refrigerant R-404a Fan Cooling Type
 Digital Control and Display
 Temp Range —12 degrees to -21c Power 1346 w Amps 8.5
 Weight 167KG 10AMP plug
 W 1900 x D 800 x H 1926 mm Including the castors
 D830mm inc Evaporator Tray H2106 Inc castors
 15 Amp Australian Plug





Do you have an ABN?
Contact us for a trade discount!



Halo KF25-1G Freezer 574 litre RRP \$5095 + GST

Temperature range -21c to -8c 3 shelves Refrigerant R-404a

Digital controller 4.5 Amps, Power 660w

Dimensions : 640 w x 850 d x 1926 h (including lockable castors)

Weight : 95 kg 10 Amp Australian plug Energy consumption : 16.45 kWh / 24 hrs



Halo KF25 -2G Freezer 572 litre RRP \$5495 + GST

Stainless Steel 2 door top mount freezer with two glass half doors

Door open warning Digital temperature display

Temperature range : -21c to -12 c Refrigerant : R404a

3 adjustable shelves per door plus base Weight : 95 kg

Dims : 640 w x 850 d 1926 h mm (inc castors) Energy: 16 kWh / 24 hrs



Halo KF45 -2G Freezer 1215 litre RRP \$8665 + GST

Stainless Steel 2 door top mount freezer with glass doors

1215 litre capacity Door open warning Digital temperature display

Temp : -21c to -12 c Refrigerant : R404a 6 adjustable shelves plus base

Dimensions : 1260 w x 850 d 1926 h mm (incl castors) Weight 170 kg

Energy consumption : 28.1 kWh / 24 hrs

Halo KF45-4G 4 Half Door Freezer 1210 litre RRP \$9225 + GST

Four half glass door display freezer with 1210 litre capacity

Stainless steel interior and exterior Glass doors with key lock

soft touch controller Door open warning

Digital temperature display, 3 shelves per door plus base 10 amp plug

internal lighting Temp range : -21c to -12c

Dimensions : 1260 w x 850 d x 1926 h (incl castors) Weight : 170kg





Do you have an ABN?
Contact us for a trade discount!

Halo 20 Auto CB— Refrigerated Premix dispenser

RRP \$980 + GST

The Halo 20 Auto CB is a dual pour chilled beverage dispenser ideal for storing, chilling and dispensing beverage and is built to withstand the demands of high traffic areas such as Hotels, Resorts, Clubs, Pubs, Cafeterias, etc

Operates at +2 degrees to + 10 at 30 degrees ambient temp and 60% humidity

Features

- stores two x 10Lt packages of beverage simultaneously
- Light box display
- Electronic control system. The millilitres dispensed can be controlled
- Strong durable colorbond metal liner easy to clean and is rust resistant
- The outlet pipeline is surrounded by a shield
- A removable partition can be adjusted accommodate cups at different heights
- Dual pour



<i>Halo 20 Auto</i>	Refrigerated Premix Dispenser
Construction	Power coated galvanised steel—white
Capacity	20Lt 2 x 10Lt Milk bladders
Dimensions	386 w x 572 d x 901 h (mm)
Weight	35kg
Operating Temp	0 to 10 degrees
Ambient Temp Range	0 to 30 degrees
Power Point	220—240 v 50Hz (Standard GPO)
Pouring Control System	Electronic Control system with controlled milk pourer
Controller	Mechanical
Switches	Refrigeration switch and lamp switch are separate
Energy Consumption	0.85 kWh / 24hrs
Refrigerant	R134a



Do you have an ABN?
Contact us for a trade discount!

Halo TOG AMST-24 Mega Top Salad Table RRP \$4950 + GST

Mega top salad / sandwich table 24 pans

Stainless steel 863mm deep salad table

Insulated hood with 24 pans Cutting Board Digital temp display

Temp range 1c to 5c 2 adjustable shelves

Refrigerant: R134a 4.7 Amps Power 366w

Dims: 1530 w x 863 d x 992 h On lockable castors 141 mm high

Weight 160 kg



Halo TOG AMST-30 Mega Top Salad Table RRP \$6150 + GST

Mega top salad / sandwich table 30 pans

Stainless steel 3 door 863mm deep salad table

3 shelves, 30 pans, 2 hoods

Cutting Board Capacity 640 Litre Temp range 1c to 5c

3 adjustable shelves Refrigerant: R134a 5.8 Amps

Power 440w Dims: 1530 w x 863 d x 992 h

On lockable castors 141 mm high Weight 180 kg





Salad and Sandwich Tables

Do you have an ABN?
Contact us for a trade discount!



Halo KHR9-1 Salad Table RRP \$3350 + GST

Salad Side pre table with hood

Dims: 900 w x 700 d x 978 h mm (1134 inc castors) Capacity 213 Litres 1 door 1 shelf Refrigerant: R134a Digital control Amps 2.5 Power 314w Weight 75 kg

Halo KHR12-2 Salad Table RRP \$4350 + GST

Salad Side pre table with hood

Dims: 1200 w x 700 d x 978 h mm (1134 inc castors) Capacity 309 Litres 2 doors 2 shelves Refrigerant: R134a Digital control Amps 3 Power 314w Weight 89 kg



Halo KHR15-2 Salad Table RRP \$4800 + GST

Salad Side pre table with hood

Dims: 1500 w x 700 d x 978 h mm (1134 inc castors) Capacity 420 Litres 2 doors 2 shelves Refrigerant: R134a Digital control Amps 3 Power 314w Weight 100 kg



Halo KHR18-3 Salad Table RRP \$6200 + GST

Salad Side pre table with hood

Dims: 1800 w x 700 d x 978 h mm (1134 inc castors) Capacity 516 Litres 3 doors 3 shelves Refrigerant: R134a Digital control Amps 4.4 Power 366w Weight 120 kg



ice machines

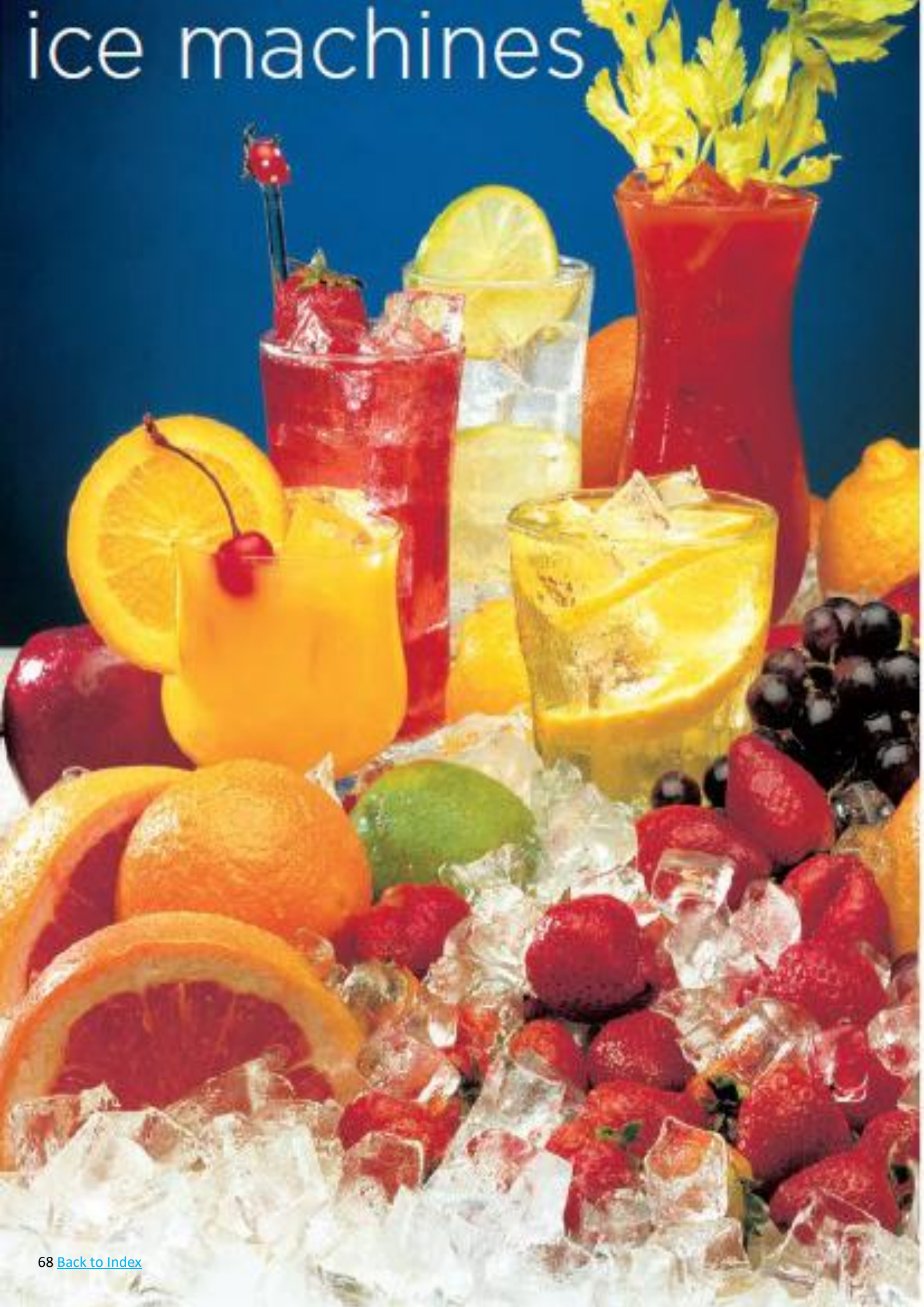

Manitowoc Ice Machines

HALF DICE



Hard, clear ice cube with unique "rhomboid" shape 3/8" x 1-1/8" x 7/8" (0.95 x 2.86 x 2.22 cm) in dimension, 96 cubes per pound of ice, maximum cooling with nearly 100% ice to water ratio.

DICE



Hard, clear ice cube with unique "rhomboid" shape 7/8" x 7/8" x 7/8" (2.22 x 2.22 x 2.22 cm) in dimension, 48 cubes per pound of ice, maximum cooling with nearly 100% ice to water ratio.

REGULAR



Hard, clear ice cube with unique "rhomboid" shape 1-1/8" x 1-1/8" x 7/8" (2.86 x 2.86 x 2.22 cm) in dimension, 32 cubes per pound of ice, maximum cooling with nearly 100% ice to water ratio.

GOURMET



Hard, clear, individual ice cube with unique octagon shape 1-3/8" x 1-3/8" (3.49 x 3.49 cm) in dimension, maximum cooling with nearly 100% ice to water ratio.



NUGGET



Easy to chew but hard enough to be dispensed without hand scooping, 3/8" (.95 cm) to 1/2" (1.27 cm) in width and length on average.

TUBULAR NUGGET



Softer texture with good cooling. Cylindrical shaped nugget with 5/8" (1.59 cm) diameter and average length of 1" (2.54 cm) with 90% ice to water ratio.

FLAKE



Small, soft pieces of ice with a 73% ice to water ratio. Perfect for displaying products and hand scooping into drinks.

CRUSHED



Manitowoc dice or half dice cubes crushed into small pieces using a Manitowoc ice machine and a Servend® beverage dispenser equipped with icepic™ ice crusher.



Manitowoc Ice Machines

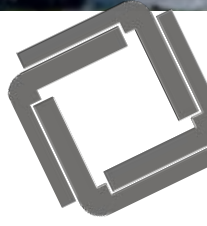

SOTTO
The clear and simple choice.

Manitowoc



UG30



UG50



UG65



UG80



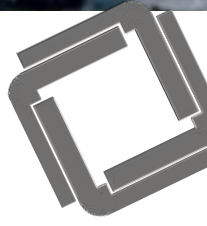

SOTTO
The clear and simple choice.

Manitowoc

Model	21 Air / 10 Water	32 Air / 21 Water	Storage Capacity	Dimensions H x W x D cm	RRP ex GST
UG30	31kg	25kg	10KG	65 X 45 X 57.5	2320
UG50	57kg	43KG	25KG	80 X 55 X 55	2920
UG65	65kg	58KG	44KG	90 X 70 X 60	3320
UG80	85kg	67KG	44KG	90 X 70 X 60	3490
Legs x 4					130

24 HOUR Production

Octagonal Cubes

All units 10amp Power

Uses gravity to drain water away



UG80





Manitowoc Ice Machines

NEO

The everywhere you need ice machine.

Manitowoc

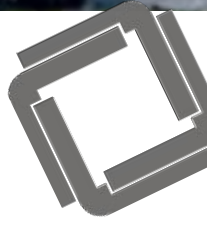

Neo U140



Neo U190



Neo U240

Neo U310



Neo Machines pump out the water



NEO

The everywhere you need ice machine.

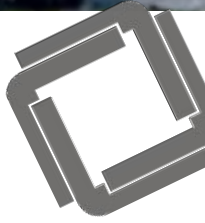
Model	21 air / 10 water	32 air / 21 water	Storage Capacity	Dimensions H x W x D cm	RRP Price Ex GST
QM45	40KG	28KG	14KG	91.4 X 50 X 56.7	3430
NEO-u140	55KG	41KG	40KG	97.8 X 66 X 71.1	3950
NEO-u190	79KG	60KG	36KG	97.8 X 66 X 71.1	4140
NEO-u240	87KG	68KG	36KG	97.8 X 66 X 71.1	4620
NEO-u310	132KG	103KG	45KG	97.8 X 76.2 X 71.5	5570
LEGS X 4 K00445	30MM			Optional	85

Standard legs supplied—Adjustable 15.24—20.33 All units 10Amp power with 2.43 mt Lead

Neo models available in full and half dice at the same price

Specs quoted are all Full dice. Half dice available. Please



1300 673 673





Manitowoc Ice Machines

INDIGO | Intelligent thinking inside the box.

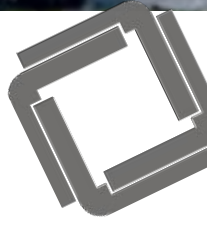

Machines for Tight Spaces



Indigo Series i-322
Ice Machine on B-320 Bin



Indigo Series i-522
Ice Machine on B-420 Bin



INDIGO | Intelligent thinking inside the box.

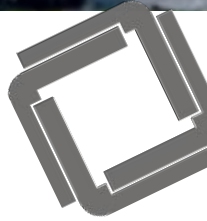

24Hr production. Full and Half cubes available.

Only Full dice quoted below. Please phone or email for other models.

Model	21 Air / 10 water	32 Air / 21 water	Dimensions	RRP exc GST
Modular Width			H x W x D cm	
I-322 Full Dice	146kg	98kg	151.1 x 55.9 x 86.4	5450
I-322 Half Dice	152kg	100kg		5450
i-522 Full Dice	207kg	150kg	181.6 x 55.9 x 86.4	5710
I-522 Half Dice	211kg	162kg		5710

Bin models to suit

i-322 : A320, A420 or A570 (requires adapter plate K00365 RRP \$200 + GST)

i-522 : A420 or A570 (requires adapter plate K00365 RRP \$200 + GST)

Model	Storage Capacity	Dimensions	RRP exc GST
A320	95KG	96.5 X 55.9 X 86.4	1650
A420	141KG	127 X 55.9 X 86.4	1820
A570	195KG	127 X 76.2 X 86.4	2070

Standard legs supplied with bins—Adjustable 15.24—20.33



INDIGO | Intelligent thinking inside the box.

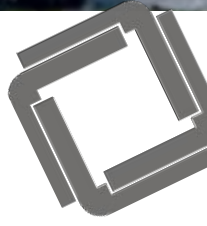

I-500 head
A400 bin



i-450 head
A400 bin



i-606 head
A570 bin



i-909 head
A570 bin



i-1100 head
A570 bin



INDIGO | Intelligent thinking inside the box.

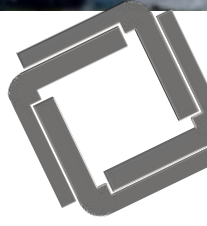

24Hr production. Full and Half cubes available.

Only Full dice quoted below. Please phone or email for other models.

Model	21 Air / 10 water	32 Air / 21 water	Dimensions	RRP exc GST
Regular Width			H x W x D cm	
i-450—Full dice	183KG	139KG	55 X 76.2 X 63	5880
i-450—Half dice	183kg	139kg		
i-606—Full dice	253KG	185KG	55 X 76.2 X 63	7140
i-606—Half dice	277kg	261kg		
i-906—Full dice	381KG	289KG	68 X 76.2 X 63	9390
i-906—Half dice	409kg	309kg		
i-1106—Full dice	497KG	368KG	68 X 76.2 X 63	10510
i-1106—Half dice	523kg	379kg		
Remote Full Dice	447	378		12650

Remote price includes JC0995 condensing unit & RT20 6m precharged piping kit

I450 & I606 10Amp power / I906 & I1106 15 Amp power 1.83mt Lead

Bin models to suit

I-1400 & I-606 : A400 OR
A570 or A970 (adaptor plate
K00458 \$470 + GST

I906—i1000 : A570 or A970
(require adaptor plate
K00458 \$470 + GST

Model	Storage Capacity	Dimensions	RRP exc GST
A400	132kg	96.5 x 76.2 x 86.4	1800
A570	195kg	127 x 76.2 x 86.4	2070
A970	322kg	127 x 121.9 x 86.4	2970



1300 673 673





Manitowoc Ice Machines

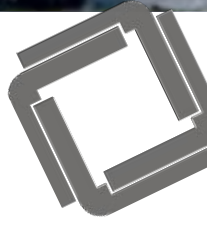

INDIGO | Intelligent thinking inside the box.



Indigo Series I-1400 Ice Machine on B-970 Bin



Indigo Series I-1800 Ice Machine on B-970 Bin



S-3070C Ice Machine - 115V



CVD Condensing Unit - 208-230/60/3

INDIGO



INDIGO | Intelligent thinking inside the box.

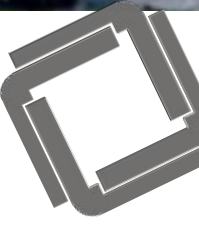

24Hr production. Full and Half cubes available.

Only Full dice quoted below. Please phone or email for other models.

Model	21 Air / 10 water	32 Air / 21 water	Dimensions	RRP exc GST
The Wide Boys				
H x W x D cm				
i-1400	653kg	503kg	194.3 x 121.9 x 86.4	12550
i-1800	801kg	623kg	201.9 x 121..9 x 86.4	15960
S3070	1203kg	991kg	252.7 x 121.9 x 78.7	32870

Bin models to suit	Model	Storage Capacity	Dimensions	RRP exc GST
I400-I800 : A970 or F1300	A970	322kg	127 x 121.9 x 86.4	2970
S3070 : F1300	F1300	599kg	161.3 x 121.9 x 78.7	8310

Adaptor Plates

A570 bin uses K-00365 adaptor—RRP \$200 + GST

A970 bin uses K-00458 adaptor—RRP \$460 + GST



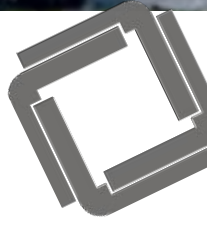

Flakers



RF0385A



RF0266A



RF0644A



RFS300A
Bin A420



RFS650A
Bin A420



RFS1200
A570 bin



RF2300
Bin F1300





Flakers

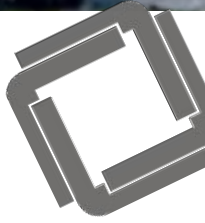

Under Counter Flakers—Head and Bin

Model	21 Air / 10 water	32 Air / 21 water	Storage Capacity	Dimensions H x W x D cm	RRP exc GST
RF0266A	77kg	63kg	27kg	95 x 50 x 66	\$5310
RF0385A	152kg	122kg	40kg	101 x 74 x 69	\$5800
RF0644A	312kg	231kg	54kg	117 x 74 x 68	\$8830

Modular Flakers—Head Only

Model	21 Air / 10 water	32 Air / 21 water	Dimensions H x W x D cm	RRP exc GST
RFS300A	174kg	130kg	66 x 56 x 60	\$5780
RFS650A	305kg	248kg	66 x 56 x 60	\$7440
RFS1200	545kg	396kg	70 x 64 x 47	\$9330
RF2300	1039kg	779kg	70 x 95 69	\$17820

Bin to Suit

RFS300A : A320, A430, A570*

RFS1200 : A570

RFS650 : A420, A570*

RF2300 : F1300

Model	Storage Capacity	Dimensions H x W x D cm	RRP exc GST
A320	95kg	97 x 56 x 86	\$1650
A420	141kg	127 x 56 x 86	\$1820
A570*	195kg	127 x 76 x 86	\$2070
A970	322kg	127 x 122 x 86	\$2970
F1300	600kg	162 x 122 x 79	\$8310
K-00365		Adaptor plate	200
K-00458		Adaptor plate	470



Manitowoc Ice Dispensers



SFA191



SFA291



DISP1000



SPA160



SPA310





Dispensers

Modular Dispensers—Order Ice Maker Separately

Model	Storage Only	Dimensions—Dispenser Only H x W x D cm	RRP exc GST
SFA191	54kg	122 x 56 x 80	\$7780
SPA160	54kg	122 x 56 x 80	\$6710
SFA291	82kg	139 x 76 x 82	\$9150
SPA310	82KG	138 X 76 X 82	\$7870
DISP500T	294kg	186 x 76 x 134	\$19430
DISP1000T	490kg	181 x 122 x 134	\$25640

SFA Ice Dispenser comes with bin inclusive of water valve

- SPA Ice Only Dispenser
- SFA Ice & Water Dispenser
- SN12A 10 Amp Power
- SFA & APS Units 10 Amp Power
- T Timed Agitation



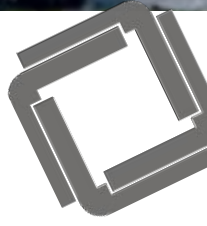

A320



A400



A420



A570



A970



F1300



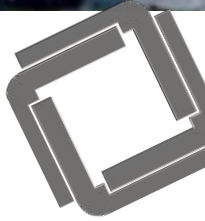

Model	Storage Only	Dimensions—Dispenser Only H x W x D cm	RRP exc GST
A320	95kg	97 x 56 x 86	\$1650
A400	132kg	97 x 76 x 86	\$1800
A420	141kg	127 x 56 x 86	\$1820
A570	195kg	127 x 76 x 86	\$2070
K-00365	Adaptor Plate for i-322, i-522 on A400, A570 bin		\$200
A970	322kg	127 x 122 x 86	\$2970
K-00458	Adaptor Plate for i-450—i1200 on A970 Bin		\$470
F1300	600kg	162 x 122 x 79	\$8310





Filter Assemblies

Model	Suitable for	RRP excl GST	RRP inc GST
BR10	UG, I up to i850	200	200
BR20	I-906—S3070	240	240
BR30	Suits pool water area	440	440

Manitowoc Commercial Warranty

Model	Parts	Labour
Sotto	2yr	1yr
Neo	5yr evaporators 5 year compressor	5 year evaporators 3 year compressor
Indigo	5yr evaporators 5 year compressor	5 year evaporators 3 year compressor
QM	3yr	3yr





Manitowoc M Series

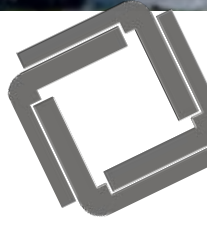

M0500
Bin A400



M0700
Bin A570

M0420
Bin A420



M01000
Bin A570



M01400
Bin A970



Manitowoc M Series

The Manitowoc M Series—simple with three controls—on, off and clean

Model	21 Air / 10 Water	32 Air / 32 Water	Dimensions W x D x H cm	RRP inc GST
M420	176kg	132kg	55.9 x 62.2 x 54.6	\$4950
Bin to suit : A320, A420 or K570 with adapter K00365				
M500	214kg	169kg	76.2 x 62.2 x 54.6	\$5340
Bin to suit : A400 or A570				
M700	290kg	228kg	76.2 x 62.2 x 54.6	6190
Bin to suit : A400 or A570				
M1000	437kg	374kg	76.2 x 62.2 x 74.9	8470
Bin to sit : A570 or A970 with adapter K00458				
M1400	645kg	479kg	121.9 x 62.2 x 74.9	10460
Bin to suit : A970				



M Series are available in three convenient sizes 22" (55.9cm), 30" (76.2cm) and 48" (121.9cm) with 6 different production ranges from 420 lbs (176 kg) to 1400 lbs (649 kg) of ice

M series ice machines are designed from the ground up to meet your operational demands for a worry-free, simple-to-use, basic ice machine; but that doesn't mean corners were cut on quality.

There are only three controls you need: On, Off and Clean.

And for cleaning, access to the evaporator and food zone is simple with the removal of just two screws and easy, lift-off door.



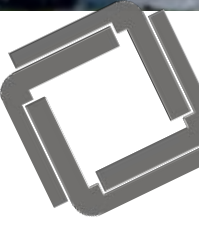

Accessories for your Manitowoc Machines

	RRP inc GST
Luminice II Growth inhibitor kit to suit i-322—i-1106	670
Luminice II Growth inhibitor kit to suit i-1406—i- 1800	670
Luminice II Growth inhibitor kit to suit Neo U-140 to U310	670



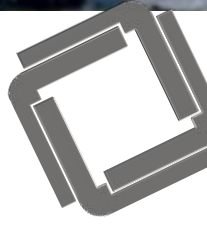

Commercial Warranty :

Neo (U), Indigo (I) and Koolaire (K) Models

- ⇒ 5 year parts and labour on evaporators
- ⇒ 5 years parts and 3 years labour on compressor
- ⇒ 3 years parts and labour overall

Sotto (UG) Models

- ⇒ 2 year parts and 1 year labour

Bins and Dispensers

- ⇒ 3 years parts and labour



- ⇒ *Requires adapter plate K-00333
- ⇒ **Requires adapter plate K-00444



Cool Room Insert Doors



Do you have an ABN?
Contact us for a trade discount!

Orford Cool Room Insert Doors



Replace your damaged or aging doors with Orford Cool Room Doors

- ⇒ Heavy duty torque masters with easy access to adjust and re-align doors
- ⇒ Self closing Doors
- ⇒ Triple glaze panels for thermal efficiency
- ⇒ Full length handles
- ⇒ Available in clear anodised, black anodised or a variety of colours with powder coating

Orford Hotel Insert Doors

Orford Walk In Doors

Single Action— kick panel size 245mm

Double Action—kick panel size 180mm

Single Action 2105 h x 760w or 2105 h x 900w

Double Action 2037 h x 760w or 2037 h x 900 w



Orford Hotel Insert Doors

Orford H1 Door Size : 658 mm x 478 mm

Orford H2 Door Size : 808 mm x 478 mm

Orford H3 Door Size : 658 mm x 545 mm

Orford H4 Door Size : 808 mm x 545 mm



Do you have an ABN?
Contact us for a trade discount!

Orford Insert Cool Room Door—Standard
1596mm x 635mm

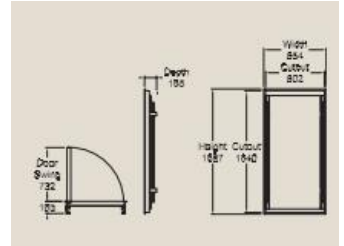

Orford Insert Cool Room Door—King
1596mm x 760mm

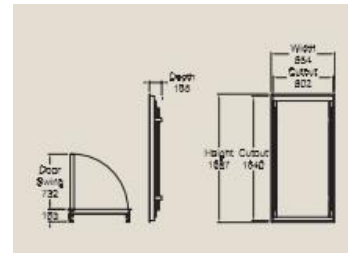

Orford Insert Cool Room Door—Queen
1793mm x 713mm

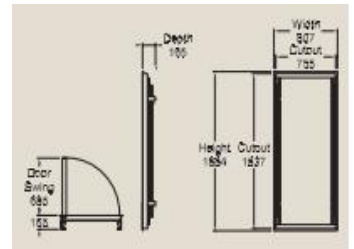

Orford Insert Cool Room Door—Jumbo
1857mm x 760mm

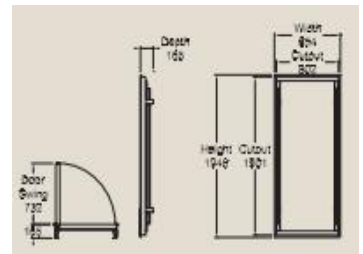

Cool Room Doors available in low temp

Medium Temp (Heated Frame only) or Medium Temp (Heated frame & Panel)

Optional Extras

- ⇒ Torsion Bars
- ⇒ Shelves
- ⇒ Powdercoating
- ⇒ Hold Open Arms



Do you have an ABN?
Contact us for a trade discount!



Anthony Orford Door Checklist

STANDARD DOOR

- 1411mm x 713mm 1596mm x 635mm
- 1596mm x 760mm 1793mm x 713mm
- 1857mm x 760mm
- Custom Size : ____mm x ____mm

Later smooth style profile only, refer to drawing.

WALK IN DOOR

- | | |
|--|---------------------------------------|
| Single Action | Double Action |
| <input type="checkbox"/> 2105mm x 760mm | <input type="checkbox"/> 2037mm x 760 |
| <input type="checkbox"/> 2105mm x 900mm | <input type="checkbox"/> 2037mm x 900 |
| <input type="checkbox"/> Custom Size : ____mm x ____mm | |

Later smooth style profile only, refer to drawing.
Brush seals not included, available as an extra where required.

Glass Panel Application

- Low Temp Low Temp Heated Panel Heated Frame
- Med Temp Medium Temp Heated Panel Heated Frame
- Med Temp Medium Temp Non Heated Panel Heated Frame
- Custom Size : ____mm x ____mm

HANDLE

- D Handle 360mm
- Full Length
- Full Rail No Handle

Note: Walk In Doors
Reuse existing horizontal handles
No holes drilled for horizontal handles
and/or door closer mechanism

Frame Colour/Hinging

	Silver Anodise	Black Anodise	Powder Coat
Door Frame	<input type="checkbox"/>	<input type="checkbox"/>	<input type="checkbox"/>
Powder Coat Colour: _____			

Kick Panel Walkin Door Stainless Steel

Powder Coat
Colour: _____

Hinge Left Hand Right Hand

Note: Determine the hinging when facing the front of the door

Extras

- Hold Open Bracket fit to door
- Brush seal for Walk In doors
- Torsion Bar Hex Head #10040
- Torsion Bar Round Head #10033



Preserve Working Capital with Orford Finance

Phone 1300 673 673

**Do you have an ABN?
Contact us for a trade discount!**

**YOURS TODAY:
EB20R-Sn-A**



Weekly payments from
\$28*

- ✓ Extensive lender panel
- ✓ Conserve working capital
- ✓ 24 hour approvals
- ✓ No financials required

Call Jessica on 1300 736 780 for more details.



*Subject to credit approval. Payments based on a lease contract over five years with a 5% residual. The lease amount has been rounded to the nearest dollar.

**YOURS TODAY:
EB36R-Sn**



Weekly payments from
\$36*

- ✓ Extensive lender panel
- ✓ Conserve working capital
- ✓ 24 hour approvals
- ✓ No financials required

Call Jessica on 1300 736 780 for more details.



*Subject to credit approval. Payments based on a lease contract over five years with a 5% residual. The lease amount has been rounded to the nearest dollar.

**YOURS TODAY:
EB45R-Sn**



Weekly payments from
\$45*

- ✓ Extensive lender panel
- ✓ Conserve working capital
- ✓ 24 hour approvals
- ✓ No financials required

Call Jessica on 1300 736 780 for more details.



*Subject to credit approval. Payments based on a lease contract over five years with a 5% residual. The lease amount has been rounded to the nearest dollar.

**YOURS TODAY:
FMB20-Sn**



Weekly payments from
\$19*

- ✓ Extensive lender panel
- ✓ Conserve working capital
- ✓ 24 hour approvals
- ✓ No financials required

Call Jessica on 1300 736 780 for more details.



*Subject to credit approval. Payments based on a lease contract over five years with a 5% residual. The lease amount has been rounded to the nearest dollar.

**YOURS TODAY:
FMB30**



Weekly payments from
\$22*

- ✓ Extensive lender panel
- ✓ Conserve working capital
- ✓ 24 hour approvals
- ✓ No financials required

Call Jessica on 1300 736 780 for more details.



*Subject to credit approval. Payments based on a lease contract over five years with a 5% residual. The lease amount has been rounded to the nearest dollar.



Flower Fridges & U



Promote your Brand —Phone 1300 673 673



Decal Sets RRP —\$240 + GST

Orford can arrange for your artwork to be printed
2 long decals (side) + 2 short (front) decals



Gravity Feed Systems RRP - \$250 + GST per door

Sold as a Per Door kit

Slip mat + 90mm shelf front + fast fit dividers

4 shelf / 35 dividers (enough for 1 door)

- Easy to adjust as planograms change
- Increase the product visibility
- Ticket stripping included

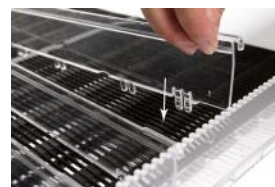

Do you have an ABN?
Contact us for a trade discount!



Roderick Abif 1 Pty Ltd (ABN 72 150 865 008) Trading as Orford Food Services

1. TITLE

Risk in any goods supplied by the seller to the buyer shall pass when such goods are delivered to the buyer or into custody on the buyers behalf but the ownership of any goods supplied by the seller to the buyer shall remain with the seller until payment in full is made for the goods.

2. WARRANTIES AND REPRESENTATIONS

All new goods supplied are warranted to be free from defects in material and workmanship for a period of 12 months from time of invoice.

The seller is not liable for any injury, loss or damage, directly or consequential, arising out of the use of or the inability to use the goods. Before using, the buyer shall determine suitability of the goods for the buyers intended use and assume all risk and liability.

3. ACCEPTANCE

An offer or quotation by the seller shall become binding upon the seller upon written or verbal acceptance of the quote or of the goods discussed verbally. Acceptance of the goods is deemed to be acceptance of these terms and conditions.

4. REJECTION

Except for defective goods supplied by the seller, goods cannot be rejected. Goods damaged during transit on the buyers own transport are not covered by Orford Foods Services insurance.

5. MANUFACTURERS SPECIFICATION

Due to continuous improvement processes, product specifications may change without notice from time to time.

All pricing shown in Orford catalogues are exclusive of GST, freight and insurance.

Warranty

This warranty applies for calls of a breakdown service nature only, for problems of manufacturing origin. Recalls, customer related problems (power supply fluctuations, thermostat adjustments, overstocking and over loading of shelves / baskets, choked condenser etc) and any other non warranty nature calls will be charged to the service call originator at normal full rates, payable at the time of the service call.

This warranty is voided, if the equipment has not been properly maintained in accordance with the manufacturers instructions supplied with the equipment, or the equipment has been subject to power supply fluctuations, misused or transported in a manner which could prejudice the correct operation of the appliance.

Orford does not reimburse or pay for costs relating to travel time, callout or attendance fees, overtime / penalty or premium labour rates or any other costs incurred or charged.

Excluded from Orford warranty are all consumable items such as glass, gaskets, lights, elements, locks, keys, accessories, decals.

All warranty work must be authorised in advance by contacting the Customer Service Department on

⇒ Phone 1300 673 673

⇒ Email : mail@orford.com.au



Do you have an ABN?
Contact us for a trade discount!



Do you have an ABN?
Contact us for a trade discount!

CABINET CLASS is a combination of Climate Class and Temperature Class as per the requirements of Australian Standard AS1731

e.g.:- 3L1, 4L2, 5L3 etc.

CLIMATE CLASS defines the climatic ambient conditions for which the cabinet is suited.

Refer table below.

Climate Class	Ambient Temperature	Ambient Humidity
	°C	% RH.
3	25	60
4	30	55
5	40	40
6	27	70
7	35	75

TEMPERATURE CLASS defines the temperature at which the appliance is capable of maintaining product, at a particular Climate Class as per the requirements of Australian Standard AS1731.

Refer examples below:

L1

At the above climate class product temperatures can be maintained between -15°C and -18°C.

As per Australian Standard AS1731.5: 2003 and AS1731.6: 2003. 5 Table 1.

L2

At the above climate class product temperatures can be maintained between -12°C and -18°C.

As per Australian Standard AS1731.5: 2003 and AS1731.6: 2003. 5 Table 1.

L3

At the above climate class product temperatures can be maintained between -12°C and -15°C.

As per Australian Standard AS1731.5: 2003 and AS1731.6: 2003. 5 Table 1.





Minimum Energy Performance Standard (MEPS) Why it Matters



Do you have an ABN?
Contact us for a trade discount!

What are the Consequences if products do NOT comply

The regulator can

- ⇒ Suspend a model's registration
- ⇒ Cancel a models registration
- ⇒ Enforceable undertakings
- ⇒ Infringement notices
- ⇒ Civil penalty orders
- ⇒ Injunctions

The regulator can publicise details relating to enforcement responses including the names of registrants and the model numbers of the products

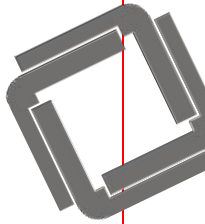

Protect Yourself

Check that the cabinet is registered for MEPS / GEMS

- ⇒ refer to the MEPS website reg.energyrating.gov.au/comparator/product_types
- ⇒ Research the cabinets MEPS figures on the MEPS website. If for example the MEPS figure is 5.8 (kWh/24hr/m²), this means the amount of total energy consumption over a 24 hour period per square metre of display area
- ⇒ If you cant find the cabinet on the MEPS site, assume it is NOT registered and therefore not legally able to be sold or used in Australia and / or New Zealand



Do you have an ABN?
Contact us for a trade discount!

Which cabinets are covered by the compulsory MEPS / GEMS legislation

- Open Face
- Reach in cabinets
- Food & Deli display cabinets
- Bar Fridges
- Glass door Merchandisers



What are MEPS Ratings?

Reference [Http://www.orford.com.au/orford-eb-energy-figures.html](http://www.orford.com.au/orford-eb-energy-figures.html)

M1

At the above climate class product temperatures can be maintained between -1°C and +5°C.
As per Australian Standard AS1731.5: 2003 and AS1731.6: 2003. 5



M2

At the above climate class product temperatures can be maintained between -1°C and +7°C.
As per Australian Standard AS1731.5: 2003 and AS1731.6: 2003. 5





**Do you have an ABN?
Contact us for a trade discount!**

Orford Refrigeration Australia

ABN 72 150 865 008

Head Office

Unit 5, Quantum Business Park

1 Gardner Crt, Wilsonton Qld
4350

National sales :

1300 ORFORD (1300 673 673)

Corby Orford : 0418 700006

Phone : +61 7 46 345 278

Fax : +61 7 46 417 372

Postal Address

PO box 18120

Clifford Gardens Qld 4350

Jeff Ash : 0400 013 958

Email : jeff@orford.com.au

Email : sales@orford.com.au

www.orford.com.au

www.facebook.com/theorfordgroup

Key Websites :

Www.flowerfridges4u.com.au

Www.orfordspareparts.com.au

Key Patents:

AUS DSN no 345317

Patent No 2013100761

“Orford” is protected by Trademark No
1452870

All images are subject to copyright and cannot
be reproduced without permission

All efforts are made to ensure the accuracy of information,
but from time to time errors may occur. Please check prior
to placing orders. This publication serves as a guide to the
Orford and partner products. Readers are encourage to
contact Orford prior to making final purchasing decisions

